

EV
A Tale of Discovery

Kenneth R. Shoulders

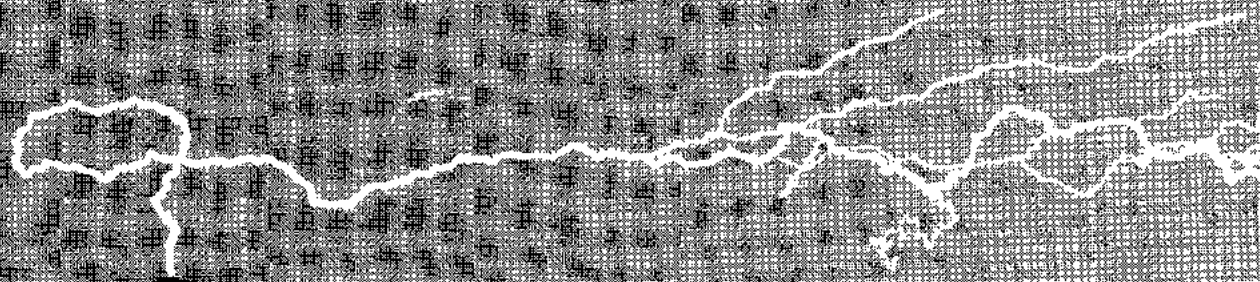

Confidential and trade secret limitations on this publication have been removed by the issuance of the following U.S. Patents to:

K. R. Shoulders

5,018,180 (1991) 5,054,046 (1991) 5,054,047 (1991)
5,123,039 (1992) 5,148,461 (1992)

Additional copies of this publication are available from:

Ken Shoulders
1025 Freestone Ranch Road, PO Box 243
Bodega, CA 94922-0243

Phone: (707) 876-1880

TRADEMARKS

Kodak is a trademark of Eastman Kodak;
Formvar is a trademark of General Electric;
Thyratron is a trademark of General Electric.

COPYRIGHT NOTICE

Copyright © 1987 by Jupiter Technologies
All rights reserved.

No part of this publication may be reproduced, transmitted, transcribed, stored in a retrieval system, or translated into any language or computer language, in any form by any means, electronic, mechanical, magnetic, optical, chemical, manual, or otherwise without the prior written permission of Jupiter Technologies, Austin, Texas, USA.

TABLE OF CONTENTS

<i>Preface</i>	ix
<i>Chapter One</i>	
PEOPLE, PLACES, AND THINGS	
The Importance of Workspace	1-1
Where We Began	1-2
The People	1-4
Preliminary Efforts	1-5
Looking for the Project	1-6
Changing Course	1-7
Supporting Structure	1-7
The Facilities	1-8
The Apparatus	1-9
The Staff	1-9
The Move to Austin	1-9
Beginning the EV Project	1-10
A Driving Thought	1-10
A Method of Attack	1-11
The Physical Attack	1-11
Revelation	1-12
<i>Chapter Two</i>	
DEMISE OF THE FILAMENT	
Comparisons	2-1
Low-Energy-Level Exploration	2-7
Following Tracks with the SEM	2-9
Synchronization Search	2-11
Mosaic Guides	2-12
Enter the Splitter	2-14
No Collision, No Cigar	2-14
Exploding and Self-Repairing Emitters	2-15
Dog Houses	2-16
Mother EVs	2-17
Still No Collision	2-18
Fission-Fusion	2-18
The Ring Cycle	2-19
On Target	2-23

Chapter Three

TOOLING UP AGAIN

A Look at Beads and Chains	3-1
Chains Unwrap	3-1
Sweep Indications	3-3
Few Wandering Beads	3-3
High Surface-Energy Gradient	3-5
Vacuum Arc on Surface	3-9
Hopping EVs	3-11
No Field-Free Regions	3-11
Mainstream Considerations	3-12
What Can I Make Them Do?	3-12
Lossy Mirrors	3-13
Gas Guns	3-15
Storage?	3-17
Coaxial Diodes	3-17
Enter the Black EV	3-21
An Unusual Breakdown Mode	3-22
Some Black EV Laws	3-23
Back to Wideband Scope Design	3-26
Bootstrapping	3-26
The Picopulser	3-26
Thick-Film Work	3-27
Cathode with Strings Attached	3-27
The Pinhole Camera	3-28
The EV is Caught	3-31

Chapter Four

THE OUTPOURING

Camera Calibration	4-1
EV Source	4-1
Charge Collection	4-2
Pulse Power Supply	4-2
Anode Current Values	4-3
Plasma Deflection and Cleanup	4-4
Charge Calculations	4-6
Camera Magnification	4-6
Sensitivity Calibration	4-7
EV Emission Calculations	4-9
EV Action	4-10
Blinkers	4-10

Energy Analysis	4-12
Kinky EVs	4-14
Consorting	4-16
Deflection Tests	4-19
Picoscope	4-20
Picopulser	4-21
Sequence of Events	4-22
They Are Short	4-23
Emission Modulation	4-27
Inductance Effects	4-32
X-Rays?	4-33
Enhanced Electron Mobility?	4-36
Speckles	4-36
Thermionic-Like Pulse Emission	4-39
Ions and Electrons Together	4-41
Black EV Strikes	4-47
Low Electron Energy Spread	4-48
Twin EVs or Dual Energy Levels?	4-51
Neutral Emission	4-53
Gas Pressure Effects	4-53
A Small Tube, End On	4-55
The Search for Ions	4-62
Summary of EV Properties	4-63

Chapter Five

EV TARGETS

No Conductivity; No Strike	5-1
Conductive Backing Plate	5-3
Thin Carbon Target	5-5
Strikes from a Tesla Coil in Air	5-7
Strikes in Low-Pressure Xenon	5-9
Difference Between Gas and Vacuum Strikes	5-13
Scanning Tunneling Microscope Strikes	5-14
Field Emission Diodes	5-17
Boring Through Dielectrics	5-17

Reboring Small Channels	5-21
Multiple-Hole Boring	5-25
Momentum Transfer	5-26
Container Distortion	5-26
 <i>Chapter Six</i>	
STREAMERS	
Pulsed RF Power Supply	6-2
The Magic of High Atomic Number	6-2
A New Glass Jar	6-4
No Photos	6-4
List of Effects Seen	6-5
Witness Plate Tests	6-7
Not Splattered Material	6-7
No Cathode Spots	6-7
Ubiquitous	6-8
Long and Short EV Sources	6-8
 <i>Chapter Seven</i>	
TRAVELING WAVES	
Are They or Aren't They	7-1
Self Synchronization	7-1
Circular vs. Linear Motion	7-2
Delay Line	7-2
Length Limitations	7-2
EVTWT Turnon	7-3
Waveforms	7-3
Multiple EV Generations	7-4
Statistics	7-4
Down in Size	7-5
Stress	7-5
Wrap Up	7-6
 <i>Chapter Eight</i>	
COMPONENTS AND DEVICES	
EV Sources	8-1
Basic Firing Sequence	8-2
The Birth of an EV	8-3
Metal Vapor Sources	8-5
Surface Source	8-7
EV Launcher	8-9
Inorganic Gas Source	8-9
Organic Gas Sources	8-11
Electrodeless Source	8-11

Separator	8-13
Operating Circuit	8-15
Pulse Duration Effects	8-15
Field Emission EV Sources	8-15
Picopulser	8-16
Film Field Emission EV Sources	8-19
Multielectrode EV Sources	8-22
Long Sources	8-22
The Gas Role	8-22
Channels	8-25
Triggers	8-27
EV Guides	8-27
RC Guides	8-27
LC Guides	8-29
Sealing Considerations	8-31
Film LC Guides	8-31
EV Synchronizer	8-32
RF Generators	8-33
Aperiodic Waveforms	8-35
Direct Current Output Devices	8-35
Using Electron Emission	8-35
Display Device	8-37
EV Selector	8-37
EV Splitter	8-39
Deflection Switch	8-39
EV Picoscope	8-43
Traveling Waves	8-47
Optical Guides	8-47
Point X-Ray Source	8-49
Circulators	8-49
Computers	8-50
Where to from Here?	8-50

Chapter Nine

GUIDELINES FOR EV THEORIES

Gradient Focusing	9-1
Spherical Monopole Oscillator	9-1
Internal Modes	9-2
Zero Point Fluctuation Drive	9-2
Reformations	9-3
Container Size Limits	9-3

Container Summary	9-4
Surface Field Measurement	9-4
Maximum Energy Extraction Rate	9-4
Communications with Guides	9-5
Soft Boundaries	9-5
Polarization	9-5
Consolidations	9-6
Charge Density Modulation	9-6
Optical Beam Source	9-6
EV Propulsion	9-7
Vector and Scalar Potentials	9-7

Epilogue

References

Index

Preface

This book discusses the discovery of a most remarkable electrical phenomenon. Even though we are just at the beginning of a new body of information on an electronic entity, whose energetics lie somewhere between chemical and nuclear binding energies, I believe this gateway will open into one of the greatest industries yet known.

The research results described in this book were financed by a method reminiscent of the scientific patronage of the Renaissance. This method has greatly lessened the need to publish results as soon as they were discovered. As a result, it has been over seven years from the basic discovery here described to the time of publication. All of these data have been a closely held secret during this time.

This electrical phenomenon, once seen, cannot be easily ignored. It is not an increment to a well-known field where one can find comforting familiarity. Under such conditions, information about the phenomenon easily provokes skeptical responses; it is fruitless to try to prevent either these or the occasional harsh comments and denials. Nevertheless, this work answers some long-standing and deeply troubling questions.

The long time lag between the initial discovery and its publication has produced a larger-than-normal volume of new information. For this reason, the description of what happened in the distant past tends to be somewhat superficial. The total quantity of the data is large; there is simply not space to describe carefully the old work and still be able to get on with the new. Of course, the natural tendency is to get on with the new and let the devil take the hindmost. For this reason the descriptions of past work are somewhat truncated.

This is, therefore, first a story, not a scientific treatise. At this point in the work there is neither enough detailed data, nor an inclination on the part of the author, to create formal scientific publications out of the observations.

We are able to say at present that the law of mutual charge repulsion has been overcome by the use of some unseen container, to the extent that a new freedom has been found in compressing uncompensated electronic charge to the average density of a solid, without the use of external magnetic fields, ions, or relativistic velocities. The exact physical mechanism responsible for doing this is still a mystery, but there are theories available to help us along that are based upon radiation containment from zero-point energy fluctuations. In spite of our ignorance of the details governing the observed processes, two conclusions are quite clear: one, that we have tapped into a higher order of energy and charge density, where even the effective values of certain basic physical constants might be modified, and, two, that a myriad of new uses will emerge.

In the absence of a guiding theory as to the containment mechanism, empirical methods have been devised for manipulation of these fiercely charged entities, and engineering applications have already yielded some electronic devices with much better properties than any other technology allows.

This book discusses primarily our most basic entity of compressed charge. The preferred size for this structure is about one micrometer in diameter, and the shape appears to be spherical, although it could have fine structure that is not yet discernible by our primitive methods of analysis. There is a distinct quantum-like preference for this size, although entities in the $1/10$ micrometer-diameter range have also been seen. This tiny bundle of charge, one micrometer in diameter, contains 100 billion electronic charges and has a very high electric field associated with it.

It seems that everything must be named, and so the little ball of charge we see has been tagged an *EV*. The notion for this name originally came up when they were thought of as an Electromagnetic Vortex. As time went on, and proof was still lacking for the vortex aspect of their constitution, I backed into a safe Latin corner and named them *Electrum Validum*. *Electrum Validum* can be translated loosely into *strong electron*. They are every bit of that, and there are times when I wish they were not quite so strong.

This beginning phase of the overall project has been named PACER as an acronym for Particle Compression via Electromagnetic Radiation. This name alludes to the use of electromagnetic energy as a containment mechanism, including possibly the use of the electromagnetic energy of the vacuum (an aggregate of virtual particles--photons) as a polarizable medium and as the source of energy for compression.

Some of my favorite books contain glimpses of the thought processes that went on behind the actual work performed and reported. Because I believe that these thought processes are even more valuable than what is reported, I am including some of my own thoughts and working methods in this writing. Also, you will certainly notice the absence of any mathematical expressions, beyond the most basic numerical ones. I don't *think* mathematically, so I don't *write* mathematically. This should pose no difficulty for those who intend to use the results shown here.

I am very device-oriented and I do not generate theories of the usual type; a viewpoint that is reflected in this writing. However, from time to time an attempt will be made to generate a theory in order to cover gaps in the observations. The measurements will always be senior to the theories generated; the theories should be thought of as a railing to guide us from one isolated observation to another, in the full knowledge that there are any number of railings available for guidance, and not all of them can be real.

The apparatus used to do this work was very simple, and this leads to the expectation that future EV technology can also be simple. Looking back on these events, I can see with certainty that I was intentionally playing the double game of finding new effects and, at the same time, doing so without complication. I am an explorer, and will not burden myself with unnecessary and cumbersome methods and apparatus. I got where I wanted to go with an economy of effort, and it was fun to do so by following nature's most fundamental law-- The Principle of Least Action.

Chapter One

PEOPLE, PLACES, AND THINGS

This chapter describes the people, the places, and some of the apparatus that came together to begin the quest for the elusive EV.

The Importance of Workspace

I am strongly affected by the surroundings where I work, both the inside and the outside. For me, the details of the working space are intimately involved in getting things right. For this reason, I spend at least half my time doing tasks that may look useless, but are directed towards creating the right conditions in the working space--conditions conducive to efficient work.

This problem of working efficiency matters, because I have to produce the devices I use myself or give in to the incredible inefficiency of having someone else do what I want done. Making my gadgets and lesser do-dads is, at best, dog work. For this reason I try to begin with a working environment that helps me circumvent all of the myriad built-in reasons to stop that seem to plague us all. Without such an environment, it is all too easy to let the problems bring us to a halt and to cease work.

Actually, it is not hard to work in a physical mode where no creative thoughts intrude on the thoughts necessary for the physical work, but, given half a chance, the creative thoughts arise and throw me off the track, spelling disaster for efficiency. A lot of tricks are needed to mix the two modes--the physical and the creative.

As I build the working space, I try to perform some of these mental tricks that potentially allow the will-of-the-wisp creative mind to coexist in harmony with the more mundane part of the mind capable of routine production. I've developed some tricks that allow me to think good thoughts and work on them at the same time; I'll let you in on some of these as we go along.

Where We Began

In 1975, having had my fill of living and working near too many people, I began building my house and laboratory in an out-of-the-way place that would have as many of the best features that I could think of to promote good working conditions. I had located a spot about 40 miles south of San Francisco that was far enough from the Pacific Ocean to avoid the corrosion problems of the salt air, but close enough to take advantage of the cool, foggy, marine air layer that invigorates me. This spot was hidden in the Santa Cruz mountains, surrounded by fir and redwood trees, with great-tasting spring water coming out of nearly every crack in the ground.

This is exactly what I wanted at the time. You can get an idea of what the place looked like on the outside from the photograph in Figure 1:1.

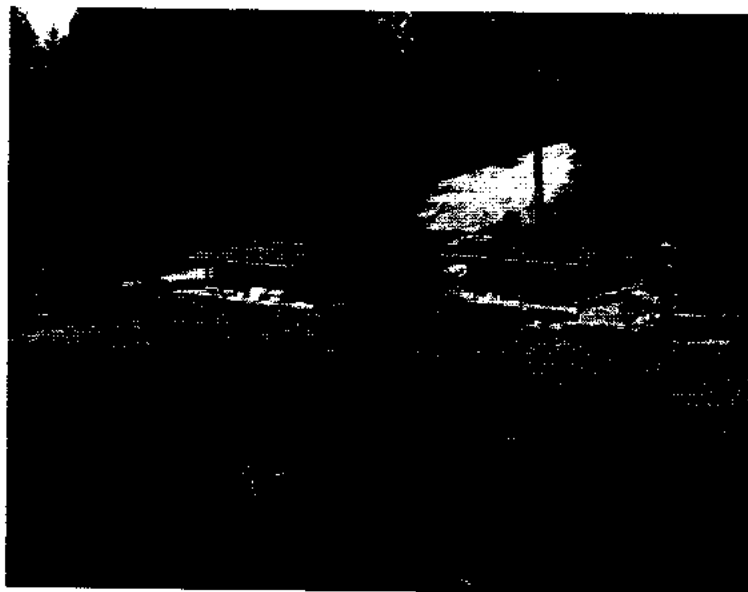

Figure 1:1

Figure 1:2 shows the conference room we often used. In attendance for that particular day, from left to right around the circle, were the dog, Ed May, Hal Puthoff, the author, and the founder of Jupiter Technologies, Bill Church. Figure 1:3 is an inside view of one part of the laboratory.



Figure 1:2



Figure 1:3

This wasn't the greatest place in the world to raise a family that needed any social life at all, but the social life would have to wait for a while. Somehow we got used to the fact that when the creek came up in the fall we could not get out in the car until late May. We had to walk over a rickety suspension bridge that could get wiped out anytime a storm brought a big tree down the creek. We survived all of this and more, and the living and working was good.

The People

One day in 1976 when I was bored with the overly predictable things I was doing and felt the urge to do something about my situation, I went to visit a friend of mine at SRI International and to seek an audition with a researcher there, Hal Puthoff, who at the time was director of a large ESP program, in the hope that I could find something "really nuts" to work on. My friend introduced me to Hal, who was trying to separate the wheat from the chaff and bring some scientific order to a messy field. We hit it off very well from the beginning because, unknown to me, he had shared an office with an ex-contract monitor with whom I had worked for many years. Thus I was not entirely unknown to Puthoff and, conversely, I had read about some of the things he was doing. What I did not know at the time is that he was one crackerjack theoretical physicist with a major quantum electronics textbook to his credit, and that, as time went on, he would come up with some earth-shaking revelations concerning the foundations of physics.

Although Hal was a Ph.D. physicist, he had set that kind of work on the back burner for a while to do his daily work in ESP phenomena at SRI. At this point in Hal's life physics was his hobby but we would soon begin to play the physics game fiercely.

After we met, practically on the spot, Hal called a friend of his from Texas who was known primarily for his fast-food business, Church's Fried Chicken. Within two days, Bill Church had come to Menlo Park, where Puthoff lived, and we struck a deal to do work in far-out physics. Bill was to provide the financing, Hal would do the theory work, and I would do the experimental things.

Actually, we also had a lot of cross-over talents that we did not know about at the time. One of the biggest surprises to me was to find out that Bill and Hal had been collaborating for some time on topics in theoretical physics, and had done pretty well with some of the really basic considerations in physics.

Bill Church is a very interesting character, not easily or simply described. If there was ever anyone who fell to earth from somewhere else, this is the guy. His methods of operation are totally abnormal but they are very effective in certain places. I am not sure how others perceive Bill in his business world, but in our scientific world I see him as a mystical inventor.

I claim that, aside from supplying all of the money to do our work, Bill is best at getting us unstuck from problems that would have stopped nearly any other bunch. He has an intuitive feel for the physical universe that comes through at a critical time when a turn in project direction is needed. When this talent of Bill's is added to the powerful way Hal manipulates physical theories, and to my experimental abilities, it all adds up to more than the simple sum of our three talents. We three have whipped some really nasty problems with a higher efficiency than I have ever seen before.

Preliminary Efforts

We tackled some earlier projects before taking on the project that is the main subject of this book. Those projects were even less complete than this one that I am reporting on here, and our methods would undoubtedly be criticized by the stodgier members of the scientific community. Yes, I am fully aware that the way I handle a subject, both the actual work and the description of it, is not in full alignment with the more conservative standards of the scientific community. I like the way I do things, and this deviation from the norm does not bother me too much because I am very effective as I am. Suffice it to say that all of the earlier work done served as a good background and in some way set the stage for the present work.

I usually work with so many choices of what to do that there must be a very selective process at work to narrow things down. In my world there are far more good things one could do than there is time or resources to do them. The key to efficient progress is finding the best way or path out of a selection of at least hundreds of alternatives.

Looking for the Project

Our principle goal throughout most of the exploratory work was to find an interesting energy source. Our basic inclination was to search for this at the elementary particle level; we also had a strong bias not to invoke nuclear processes. We were not left with many well-known theories to go on, and so our search took us into many strange places. We were well equipped for such travel. We were a physicist who was also working on ESP phenomena, a mystical inventor, and a maverick thing-maker. We could see no terror in any of the dark alley ways of science we went into. This journey would make Oz look like Main Street, USA.

In the work preceding this project, and toward the end of one of my forays into a dark scientific alley (having to do with destabilizing electrons and thereby obtaining their annihilation energy without the use of positrons or anti-matter), I was totally surrounded with theories of elementary particle structure formed from vortical flows of primeval substance. These theories were expostulated by Shekhawat, Jehle, Larson, Kraft, Golko, and a host of others. All of these notions showed the possibility of stable, quantizable, force-free structures that could be taken apart by some process that would yield energy gain. Thus I was plenty tuned up for vortex notions and was thoroughly into all of the tricks that fluid vortices play in either regular fluids or superfluids. I was ready for an experimental attack on the elementary particles and had actually started some exploratory experiments.

I remember that about this time I was feeling pretty much alone, and I felt that this exploratory journey was going to be a long one. I must have thought how nice it would be if something really easy would come along. I suppose I was doing a review of the easy things, such as the plasma vortex work of Wells and Bostick, when the notion struck me forcibly to call Winston Bostick, of the Stevens Institute of Technology.

I did call Bostick and he told me that in just a few days there would be a conference (in San Diego on November 10, 1980) and that we could meet there and talk. We met and we talked, but we did not talk about the regular old-type plasmoids on which he had published earlier. Instead we talked about the electron concentrations he had been seeing in an electron beam he had made by using a plasma focus machine. Bostick called these effects *vortex filaments* [Nardi *et al.*, 1980] and the word *vortex* sucked me into them. I had been well prepared to deal with that subject and this looked like a great way to apply what I knew.

It was clear that the phenomena Bostick alluded to had something of interest in it. Since most of my experience in the physical sciences had dealt with devices plagued with space charge problems, I had a sore spot there from being rubbed so much and was ready to reach for any ointment that promised relief. There was something in these *vortex filaments* that promised relief. If one could believe the numbers, they were already in gross violation of the space charge law. Possibly there were mitigating circumstances, such as enormous local magnetic fields, that permitted their existence. Whatever the reasons were, I was in no mood for reason. I simply grabbed onto this effect and began learning all I could about it. All other thoughts and approaches went down the tube and I was to be locked into this area for the next several years.

Changing Course

This description of how I got started may seem to suggest that it was easy to turn from one thing to another or to abandon a year or more of work on something that once looked so good it was the only thing in my life. It was not easy at all.

It is very hard actually to steer to a new course when heavy commitments have been made to an earlier route. One of the finest things about our organizational structure was the nice balance we could maintain between doing enough concrete work to serve as a guide in the physical world and still maintaining the mobility of alert minds.

Supporting Structure

I cannot accurately describe our process of decision making but I do know that it contains elements not usually found in contract research work. For one thing, we have never written a proposal. We even had a motto: "It is all right to be wrong to be right." Actually, I was always reluctant to test this hypothesis too much, so I modified it for my own purposes by saying "It is all right to be wrong to be right, ONCE."

There were no reports, or even letters, required as descriptions of the work. We all knew what we were doing and what had to be done. Any formal structure would only serve to destroy the mobility much needed at this point in the work. The time would come when the standard structure would be needed, but for now I could use a technique I call "skipping."

I would skip *around* hard-to-do things, never hitting them head on. We did not have the right kind of power for head-on confrontations. I would skip over work areas that seemed unessential at that particular time, although I knew full well that someday someone would have to fill in that quagmire to allow the army of workers that might follow to cross over it. At the time, I thought: "Why should I bother filling it in now; the army might not be coming this way anyhow."

Some people might wonder how it happened that an individual like Bill could support such an effort without crying daily for some kind of spin-off product or whiz-bang that could make a buck. I wondered about that too. One of the ingredients Bill had in his makeup, which allowed us to proceed into the far reaches of physical science, was his ability to do just that. I was constantly aware of the need for conservation of resources, and being a natural pinch-penny helped. Still, I never once felt any pressure to hold back on what we judged was right to do.

For Bill, what was right came before all else; I was the one that had trouble going out to the thin leading edge of "right." Although I greatly prefer skating on thin ice, or exploring as far into the woods as possible looking for the Holy Grail of science, it is absolutely necessary for me to have someone's hand to hold. Bill and Hal and I formed a chain of safety for each other, and we could all go a long way into the woods without feeling too threatened by it. I doubt if I would have gone alone; I might well have turned back to something safe.

These formative years leading up to the actual work on the EV were really good years. Looking back upon this time sometimes gives me the illusion that nothing but joy stemmed from the magical methods we used.

The Facilities

In the beginning of this experimental work the laboratory consisted of a building of about 1200 square feet, designed to be either a house or shop. An additional building, of about 500 square feet, was used to house apparatus too crude for the laboratory space and also used to store the junk that is always a part of such a lab. A few years after the beginning of the project another 1500 square foot barn-like structure was built to house the heavy apparatus and dirty process work that had overflowed from the laboratory.

At this level of development these facilities were useful and productive, and for several years I worked alone here doing all of the things that had to be done.

The Apparatus

The apparatus available in the beginning was pretty pitiful and could easily be described as appropriate to a garage operation. The only saving grace was that this apparatus was mostly hand hewn with tender loving care by an old instrument maker (me), and it could do wondrous things. As time went on and the pace of the project quickened, many purely commercial items were added and they were mostly general-purpose tools. Special-purpose devices were not purchased because of my deep convictions that forefront work required forefront tools. The tools we needed always had to be made because there was not enough market to encourage industry to produce them.

The most obvious exception to this was a Scanning Electron Microscope that was purchased to save time in building a low-energy electron interferometer used on a previous project. A homemade interferometer would have been better, but time was of the essence. As it turned out this SEM was the key instrument in discovering the EV and we had made a fortuitous decision in buying the SEM.

The Staff

There was no subcontract work and no administrative personnel in my laboratory. I was the whole show and I loved it, most of the time. Of course it got lonesome, but then I was living where I worked and could always go into the house for a chat with Claire, my wife. That helped a lot.

In mid-1981, my son Steven began constructing laboratory apparatus for me and it was clear that he had a talent for such work. This was a good time for him to begin working with me because some relatively routine work was becoming available as I settled down to serious EV work. Except for an apprentice, and other part-time help I used for production of two electron cameras, Steven and I were the entire experimental staff until we moved to Austin, Texas, early in 1984.

The Move to Austin

In Austin we put together a standard laboratory with real employees and a manager. We intended, in this laboratory, to do what might be called development work. It was also our intent to begin building a proper research laboratory that I could feel really good about. It turned out to be quite a chore to find an acceptable place to build the laboratory and so this effort was delayed for nearly two years before construction could even begin.

Beginning the EV Project

Let's jump back in time to November, 1980, when Bostick first told me about vortex filaments. The day after that meeting I wrote in my notes: "Is this the electron laser?" I was thinking that the coherence implied would produce the particle equivalent of a photon laser. I also made entries in my notes of plans to condense electrons to the density of a solid by using the techniques I had just learned about and the guidelines published by Malmberg [Malmberg and O'Neil, 1977, pp. 1333-1336] stating that densities of 10^{20} electrons per cubic centimeter could possibly be condensed with modest electron temperatures and magnetic field strength.

Nardi, an associate of Bostick, had also stated that there was a degree of electromagnetic guidance available for these vortex filaments, and to me that was an essential parameter. Almost immediately I had vast plans for further cooling the electrons by adiabatic demagnetization and spontaneous cyclotron radiation to get the necessary degree of coherence that was implied in the order shown by the vortex filaments. Older plans for using free-standing vortex rings of intense solid charge to promote electron annihilation were dusted off. In almost no time at all everything converged to say that this is where I would stand for the fight to come.

A Driving Thought

Although on January 31, 1981, I had made a formal statement declaring an official switchover from "theory work," (which to me means not building anything but thinking a lot about it) to experimental work, I had let a few theory thoughts creep in. One of the most significant papers I found during this period was one by Bergstrom [Bergstrom, 1973, pp. 4394-4402].

Bergstrom declared that there really was something like an ether, and that it was dielectric in nature and therefore polarizable. He said that many effects would arise from this, not the least of which would be a single method of containment for charge of a single kind ranging from elementary particles to ball lightning. Bergstrom literally set me afire with his paper, but try as I would, with and without his help and the help of other great physicists, I could not get a grip on the physical reality of what he was saying. I knew there was a lot of truth here but I could not use it. I just stored the data for later use. As it turned out, Puthoff worked to clear up the matter much later and gave us another grip on our new world.

It is a puzzle to me how people, including me, think they know where they stand when there is nothing but thin air under them. It is certainly clear from where I stand now that I did not know anything really important about what was to happen following that meeting in November 1980. Yet, I have been able to follow unerringly a tenuous path laid down at that time. I love this process of projection into the future, and I hate the paltry roadblocks thrown up minute by minute as we proceed down the projected path.

A Method of Attack

Everybody has their own methods for getting ready to solve a problem. Mine is to tool up with every gadget that I can think of that will apply to the problem. I never think about what I can buy; I could never afford to do that. I start designing specialty instruments and tools to help solve the problem. I back way up into the basic technologies that these instruments stem from, and come out of the corner with something specific to hit the problem with. Of course I take a lot of big swings that miss the mark, but all is not lost because I can always put the gadget away and use it another day.

For this fight the tools I chose were a very short-pulse vacuum Marx generator for driving a miniature version of the plasma focus machine. I would also need an especially fast oscilloscope to see what I was doing. Both of these would be built, and customized to the work, using flame-spraying of metals, insulators, and resistors as the basic construction technology for the instruments. Boy, was I nuts!

I always do this kind of nutty thing when I am working best. I think it is some kind of threat waved at the problem or a mystical scheme to scare away the devils. I rarely ever do anything as cuckoo as I threaten, but the pattern persists. You can see why I don't get along too well writing proposals a year in advance and then sticking to them. That kind of working structure would drive me over the edge.

The Physical Attack

A lot of time went by as I tooled up for the onslaught. I flame-sprayed oxides, metals, and carbides on all kinds of substrates. I designed special fixtures, shields, gas mixers, miniature nozzles, and high-velocity guns. The detailed design of a miniature high-vacuum Marx generator, capable of producing 1 nanosecond pulses of 500 kv, had taken shape and the construction technologies were in good order.

I was testing one of the Marx storage capacitors for breakdown limits when I noticed an unusually straight, narrow, and uniform breakdown path on the surface of the dielectric. This was one of the most normal things you can see in vacuum breakdown over a dielectric surface and I had seen it hundreds of times before in my life but the bell rang when I saw this one. Somehow all of the previous data I had been gathering came to the fore and said "This streak is not just a streak; look at it carefully."

I put together some thoughts on how to test the thing I was looking at and the notion came to me to use the witness plate technique that plasma researchers use. I got a piece of brass foil 0.001 inches thick and put it under the dielectric electrode I was testing so that the discharge would strike it instead of the main test electrode. The voltage was raised to about 20 kv; the discharge occurred; the path of the discharge went straight to the center of the foil and a miniature explosion occurred that coated the ceramic with brass and left a tiny mark on the brass.

Revelation

In the optical microscope the mark was interesting but not entirely distinct. I fired up the Scanning Electron Microscope and took a look. The mark I saw was identical in size and shape to those obtained by Bostick in the plasma focus machine and the TX-25 relativistic electron beam machine running at several megavolts.

This telltale mark signaled the presence of the vortex filament I had been seeking. I had arrived, and all of my fancy Marx generator and fast oscilloscope work went out the window and into the barn. It was May 15, 1981, and I had wasted all of that time working on the wrong thing, or so it seemed at the time. I was literally crushed in the face of success.

Chapter Two

DEMISE OF THE FILAMENT

There it was. The unmistakable fang mark of an EV and it had been made by the simplest process in the world instead of by using an atom smasher. I was ashamed to have been sucked into going the long way to get to this point, but at least I now had presence of mind enough to recognize the need for simplicity and smallness to unravel the remaining knots. I could easily see that large machines and high-energy discharges were good for justifying large budgets, but not for finding the answers I needed. Low voltage and low power were the solutions to many of the detection problems facing the EVologist.

These little EV devils had been hiding in the plasma trash of almost every spark discharge since the time a few billion electrons could get together. I was determined to find out how they had hidden from so many people for so long. To do this, I hit the literature.

They were everywhere I looked. Lafferty [Lafferty, 1980] had edited a book about them under the heading of Vacuum Arcs. Mesyats [Mesyats, 1983] had a beautifully elaborate description of the birth of a cathode spot in an arc that was probably the creation place for an EV. I was inundated with data, but I was most humiliated when I went back to the work of Boyle [Boyle *et al.*, 1955] and Kisliuk [Kisliuk, 1956] and found strike mark photographs on electrodes of relay contacts operating at 25 volts or so. I had used these references in conjunction with earlier field emission work I had done and was thoroughly familiar with the work but had somehow overlooked this point.

Why hadn't I checked the literature before? Because I wouldn't have seen what I was looking for anyway. Bill has made me very aware of this effect with his name for it. He would say, "you don't have confront," meaning that I was unable to *see* the truth at this time even if I were looking straight at it. There is a certain time when we can, or will, accept the truth and not before.

Comparisons

Let's compare witness marks on some photographs to see some of the similarities, despite the different conditions under which they were made.

Figures 2:1, 2:2, and 2:3 were made in a TX-25 relativistic beam machine operating at about 5 megavolts.

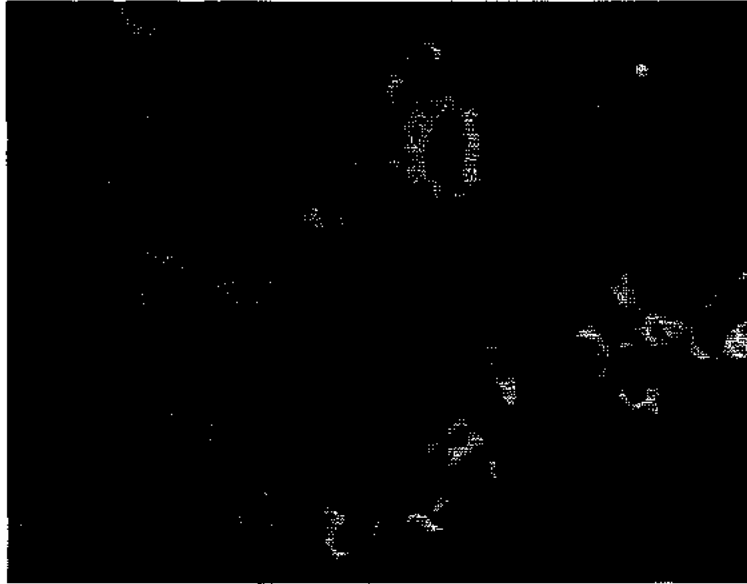

Figure 2:1

The pictures in Figure 2:1 thru 2:3 were given to me by Winston Bostick when he was working on the TX-25.

Figure 2:1 is a scanning electron micrograph of the witness plate while Figures 2:2 and 2:3 are optical photographs. In both cases the witness plates were 0.001-inch-thick titanium metal foil placed at the anode of the discharge.



Figure 2:2

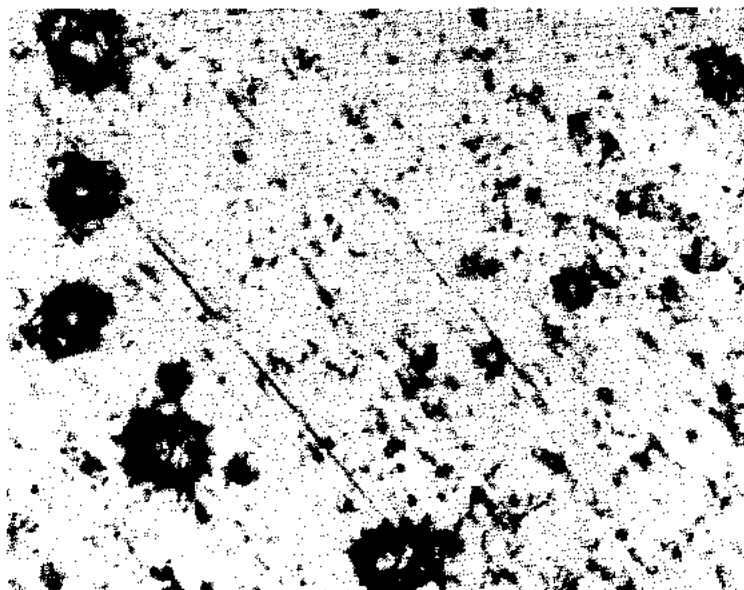

Figure 2:3

Figure 2:4 was made in a vacuum discharge at 10 kilovolts using apparatus somewhat similar to that shown in Figure 2:5.



Figure 2:4

If you direct your attention to the isolated splash marks in the photos (Figures 2:1 through 2:4) you can see that they are remarkably alike in spite of the energy differences between the two experiments. In Lafferty's book these shapes are referred to as *morning glory structures* and are usually found on the cathode electrode. Some identical structures are found on anodes but the operating conditions for producing these are much narrower in a standard vacuum arc for the generation of anode strikes.

There is absolutely nothing fancy about the structure shown in Figure 2:5 on the following page.

The cathode can be any conductor I know of; the dielectric can be any insulator such as ceramic, glass, plastic, or vacuum.

The EV is formed and propagates to the anode whenever the direct current or pulse voltage rises to the point at which field emission begins a runaway switching process aided by metallic vapor from the cathode emission site. This process happens 100% of the time.

The worst thing about this simple apparatus is that the voltage gradually rises from shot to shot, due to cleanup of the emission sites, until an equilibrium value is reached at some high voltage.

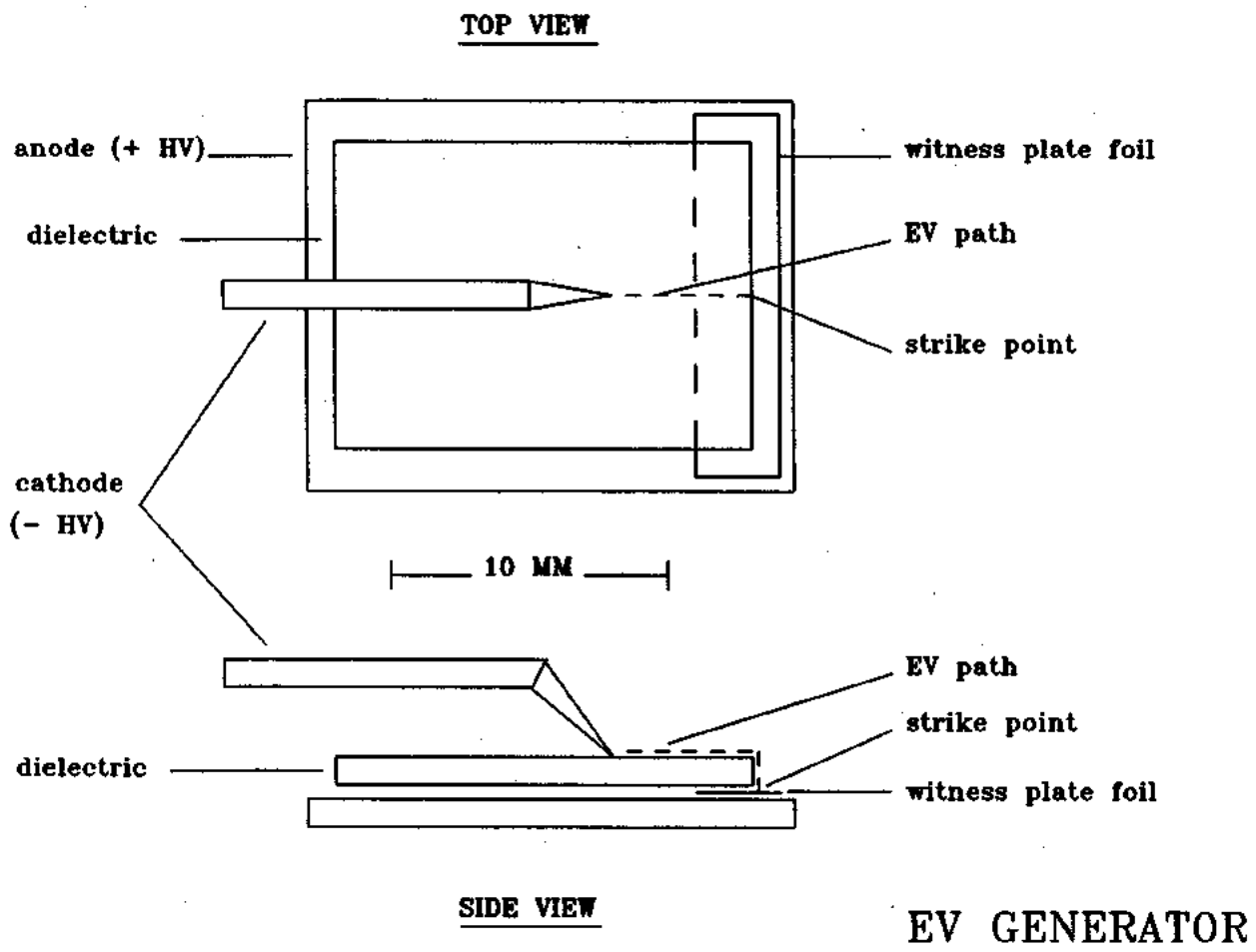

Figure 2:5

I looked at these witness mark structures a long time, as others have, wondering why there is no really prominent line structure depicting the flow of the end of a filament of energy over the surface. If these are filaments depositing their energy, why are they so locked in position and unable to draw lines by either moving or striking in a skewed fashion? Why always straight on into the surface without error?

I was told by those in the know that this is the way, and that there were reasons, and that even the length of the filament can be known by certain magical manipulations. There are image forces, you know. OK, OK. Somehow I was not satisfied.

Low-Energy-Level Exploration

I started putting the EVs through their paces. I found what materials they could be formed from, what they ran on best, and what made the best witness anodes. This was a time for wild, run amok, Edisonian experimentation. Nothing was sacred. I would have used shoe leather for a dielectric if mine had not already been worn too thin. It is for sure that nails worked for cathodes any day and did not do too badly as anodes either!

I found the demon EV loved to run in grooves and hide in cracks, the smaller the better. It even prefers running in totally enclosed structures, such as in tubes and between plates, to running in the open. At this point I was convinced EVs were female because of the way they are always looking at their mirror image in dielectrics.

Up to this point I was still trying hard to break away from the convention of plasma physics and fusion work where bigger is better. I was using a 40 picofarad capacitor for the energy storage source and a mechanical vacuum switch to discharge the capacitor. At 10 kv this represents a lot of energy and the EVs made were covered up by a big and nasty discharge that obscured a lot of the details I was looking for.

One day I went to the smallest cathode capacity I could make for the discharge by isolating a tiny piece of metallic material on the tip of a resistor-coated ceramic rod. With this configuration the capacity of the discharge was below my ability to measure easily (about one picofarad). The EVs came out as interesting as ever from this source of below 10^{-6} joules of energy.

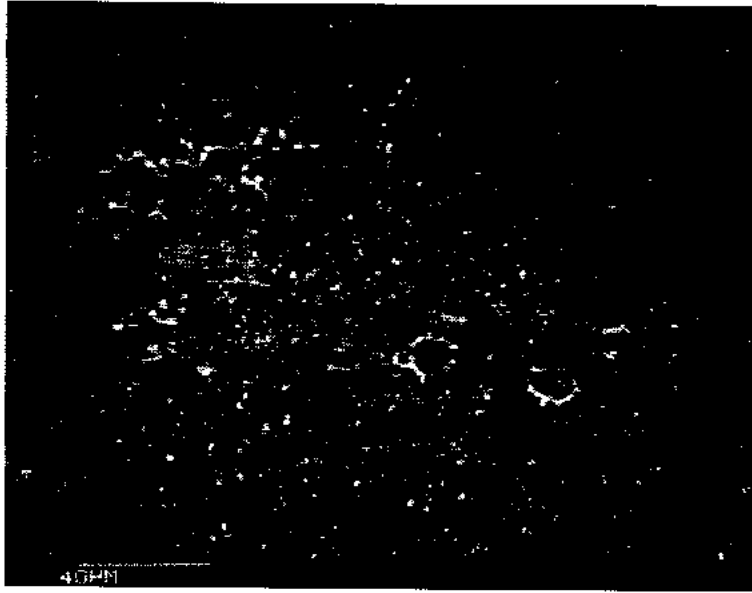

Figure 2:6



Figure 2:7

The photos in Figure 2:6 and 2:7 show an SEM image of the witness plate of titanium.

The energy used here stands in great contrast to the 1000 joule shots of the plasma focus machine. The small, round, bright spots on the photos are deposits of molten metal blown off during the discharge. There is a large distribution of strike mark diameters shown in the photos. The magnified view in Figure 2:7 shows some clear strikes of 1 micrometer in diameter. The largest size is limited to about 10 micrometers in diameter. During this low energy push, I flame-sprayed aluminum oxide onto various metal anode backing plates to a thickness of about 0.005 inches and generated beautiful EVs at 2 kv applied voltage.

The cathodes for these tests were usually brass or copper wire and, as the sharp points were knocked off by the discharge, the voltage would rise from shot to shot.

Following Tracks with the SEM

I became interested in seeing the track the EV made by some method other than optical examination of the plume it left. The SEM was set up to accommodate making EVs inside the vacuum chamber and the beam was set up first to adjust the surface charge to whatever was needed to make the EV happy, and then the EV was fired and the surface was analyzed for charge redistribution by running the SEM at very low current so as not to disturb the charge pattern. Figure 2:8 and 2:9 show examples of this kind of operation.

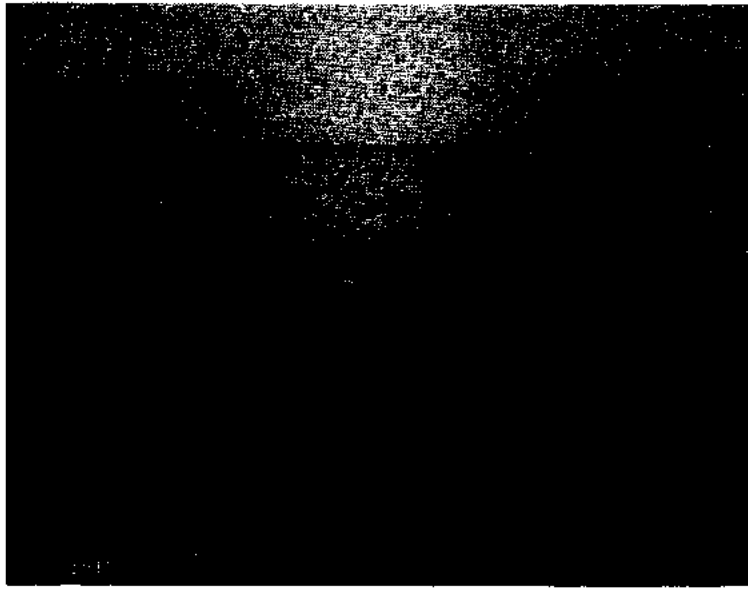

Figure 2:8

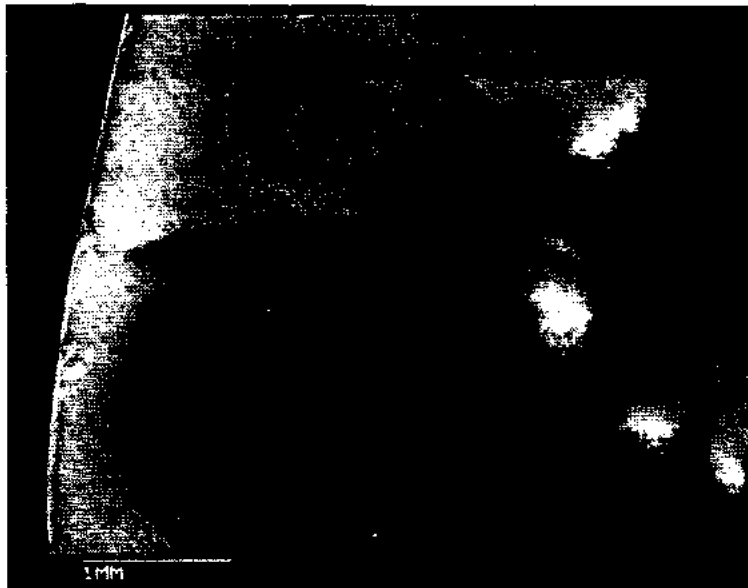

Figure 2:9

Figure 2:8 is a calibration run using the beam of the microscope first to deposit charge in a simple line pattern. After the charge is deposited the picture is scanned and the charge shows as a dark line going from left to right. There is also a square pattern of charge showing on this particular run. The rough line below the center line is a scratch on the ceramic surface. These charge patterns can be wiped off by adjusting the electron beam energy and charging the surface to equilibrium.

Figure 2:9 shows a ceramic surface that had numerous EV runs made on it. The bright spots arranged in a semicircle represent the initiation spots near a large cathode wire on top of the ceramic using a configuration similar to Figure 2:5.

The streaks running toward the edge of the ceramic are discharge trails. Often these discharge trails can be seen to follow small scratches on the ceramic surface. Nothing much was learned by using this method except that there was charge scattered all over the surface. This is one of those places in the work where, if I had persisted with the measurements, I would have learned something of value, because, as it turned out, charging surfaces were going to be a pain. I slid right on by this good thing.

Synchronization Search

It was time to hit this vortex filament shape problem again. I was going to find out how long they were, and how variable the length was, and what caused it. The perfect scheme for this would be a coincidence method whereby one filament would be used as a probe to measure another. This is just a variant on particle scattering and collision cross-section work.

What I needed were two sources that could be fired synchronously with a variable timing on one to control coincidence. Good luck! The times of interest here were somewhat less than a picosecond of jitter in firing to achieve even half-reasonable results. Nobody in the world had come close to that. So I stumbled on in my inimitable way to make two sources of EVs that were synchronized to better than a picosecond.

As you can well imagine, there were a lot of trials and there were a lot of test techniques, and knowing when I had a good result was at least half the problem.

The main attack in this encounter was to use one EV source to trigger another and still have something left over from the first EV to become the target for the collision experiment using the clone, delayed in time, as the bullet. After all, these were just fierce bundles of charge and could be handled like more ordinary electronics if one cranked in enough constants to offset their brashness. Easier said than done. I tried a lot of dopey things that seemed reasonable at the time but the combination of poor generation technique and poor measuring technique kept me out of the picosecond domain.

Mosaic Guides

While maneuvering to do this, and to conquer time jitter, I had evolved a technique for guiding EVs around in the complex circuits that had developed. The finished parts looked like miniature tile floors that had been laid by a two-year old child, and so I called this the *mosaic technique*.

It consisted of cutting out little parts of sources, guides, and whatnots and gluing them down to the base ceramic plate that had become the starting point for nearly all experiments. An example of this kind of structure is shown in Figure 2:10.

An anode was flame-sprayed underneath and an array of cracks or 90-degree edges were formed on the top by bonding down other ceramic bits. The EV greatly preferred to follow the boundary of a 90-degree corner made to the substrate by these bonded ceramics or glass parts instead of following a flat surface.

Two other mosaic features shown in Figure 2:10 are the movable guide and the launcher. The movable guide is used as a time-delay unit in the example shown and is accomplished by putting a bevel on the section of the guide that is made movable. This particular placement of the bevel causes the EV to leave the straight wall for the beveled wall, thus allowing the EV to proceed to the launcher instead of continuing around the same piece of material onto which it was originally locked.

The launching function is accomplished by using an acute angle at the end of a guide. The EV would rather go forward onto the flat substrate than around the sharp corner. Considerable care is required in making the launcher edges; otherwise random launching angles result.

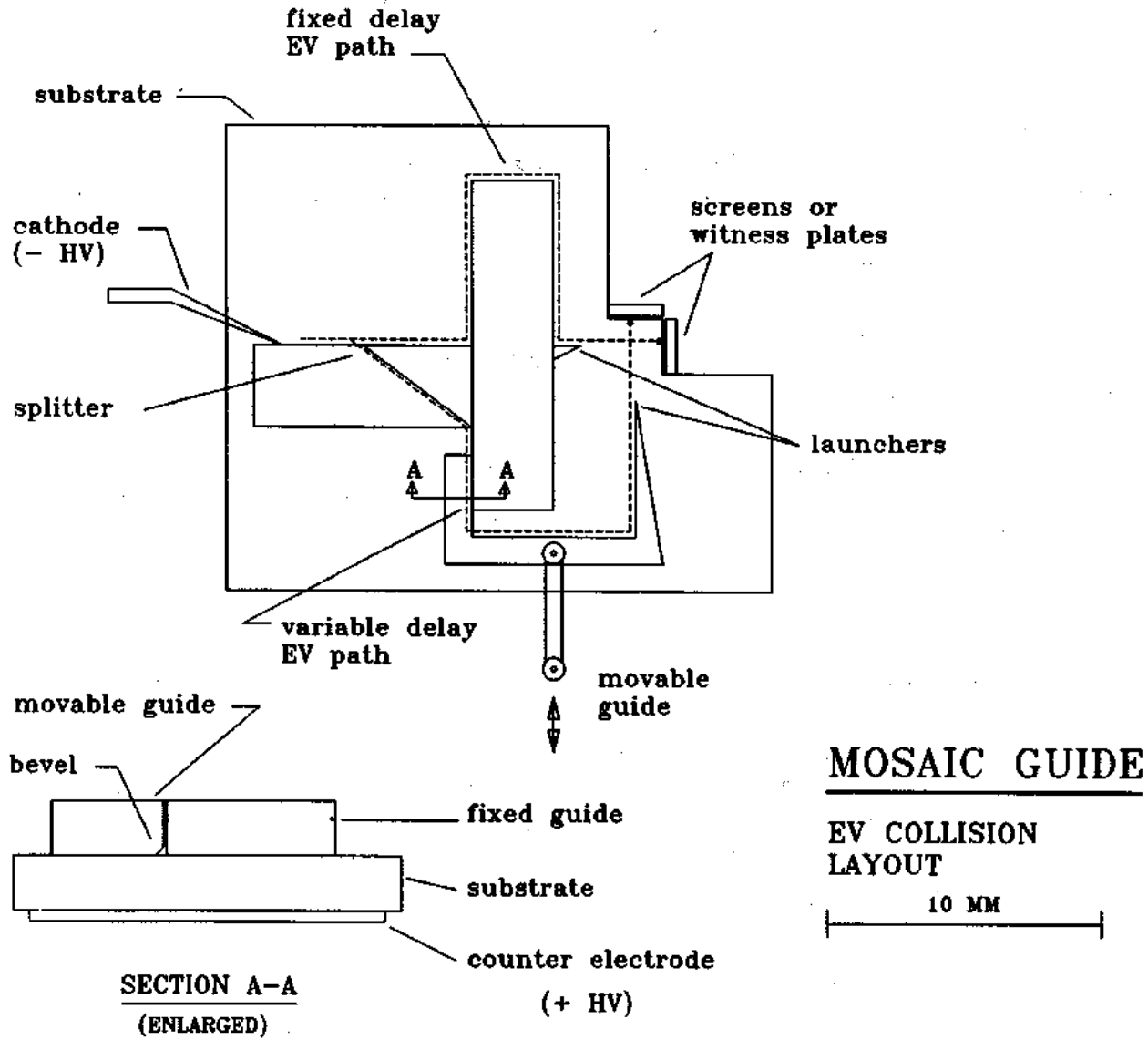

Figure 2:10

Enter the Splitter

One of those happy accidents occurred during the bonding of a ceramic mosaic tile to the substrate with water glass. Water glass dries by evaporation and it requires a path out to the air to do that. If you don't give it a path, it makes one. Between the two pieces of ceramic an intricate web of canals had been formed with dimensions of a fraction of a thousandth of an inch. These tunnels were open throughout their length to accommodate the loss of water for drying. The space between the plates looked like a miniature two-dimensional termite nest.

I did not notice the drying error until after I had tested the part and found it weird. When I put an EV into the input of the guide, I got at least a dozen outputs. I had made a splitter for EVs. It was clear immediately that this would do what I had wanted to do with the double-source device. All I had to do was delay the path of one of the outputs with respect to another and collide them.

In an effort to make a neater structure to control the EVs and to improve on the mosaic technique, I tried grit-blasting guide grooves in aluminum oxide substrates through photo-developed elastic masks. I etched pretty patterns in fused quartz and did metallizing with vacuum evaporation. In the end I returned to the mosaic because it had an edge over the others by virtue of being able to do all of the functions I needed for laboratory work on a one-off basis. I could even change a substrate that did not work out because by this time I was bonding down the chips of mosaic by quick-setting epoxy glue, and they could be lifted off by heating to the softening point of the glue.

No Collision, No Cigar

Through all of these machinations I succeeded in constructing a test unit, similar to the one shown in Figure 2:10, capable of launching two EVs at each other and performing a kind of scattering experiment with the aim of determining the length of the vortex filament. An additional mosaic guide component was added to accomplish the splitting function. The splitter is simply two pieces of dielectric material bonded to the substrate in such a way as to provide a straight path and an angle path.

It is necessary to limit the width of the crack at the split or all of the EV energy will follow this path. The trick in this experiment was to have the EVs from the splitter go through their respective mazes and hit a target of either a phosphor or a simple witness plate giving off light from the plasma plume.

Everything seemed to work, but there was no answer. The two darned EVs seemed to pass in the night and rarely do anything else. No interaction. Several times as I dutifully tuned the time delay unit for coincidence (a very blind operation) I would see something like a deflection of one path and it would usually be in the same place on the target as if a quantum effect were taking place.

This experiment would win no cigar. I was constantly plagued by charging of the dielectric surfaces and this may be what did me in. As much as I wanted this one to work, I gave up. It was time to skip a little instead of hitting my head on the substrate. I'll let you in on a little secret: it never really occurred to me that the problem may have been that the EV length was so short that the probability for coincidence was just too low with the apparatus I was using.

One thing that I did get out of this series of mistakes--a repeated observation that under certain conditions the visual trail of the EV would vanish, but the EV would still be there. There were many instances when the EV would go around part of the complicated circuits in a totally invisible fashion and thus it earned the title of "black EV." I'll have a lot more to say about this later.

Exploding and Self-Repairing Emitters

Cathodes or EV sources that would not operate at constant voltage were a pain in the neck and so I attacked this problem. I knew of liquid metal field-ionization sources and had played with them a little on earlier projects. I remember having once had the power supply turned around backwards, making the liquid metal tip the negative electrode or cathode. This caused a monstrous blow up at the cathode, not just once but many times.

I must have half-way reasoned that there is a self-repairing process at work here. I set about trying the process in a way that, from where I am now, seems like the hard way. I put a titanium coating on a graphite tip I had made by mechanical process. The coating was reacted with the graphite by heating in vacuum and titanium carbide was formed. I knew this would allow aluminum to wet to it. A little aluminum was applied and the composite reheated until, at about 600 degrees centigrade, the aluminum flowed on the surface. A negative voltage was applied to this cathode assembly while the aluminum was molten, and, lo and behold, EVs started showering off.

I ran the thing for quite a while just to amuse myself. I needed something like this so much, and it felt so good that I was totally blown out for the rest of the day and just took off for the tall and uncut where I could be with Mother Nature and thank her for this little gift. This modest success was followed by another and another. I made EV sources out of everything in sight.

I used mercury on copper and silver. That worked great. I used alloys of gallium indium and alloys of tin lead and they both worked well. I ran some conductive glasses such as boron oxide at 900 degrees centigrade to see how this class worked. Just middling, but it worked. I tried organic material in the form of sodium-iodide-doped glycerin and that was OK. In all of this wild melee, I even ran nitroglycerin that was nitric-acid-doped for conductivity to see if I could get an entirely gaseous source that did not leave a metallic deposit. It was fine.

By this time I had a good grip on what the basic processes at work were, and I ventured forth to a different class of sources that were not totally self-repairing as the liquid ones were, but they had some redeeming value. These were the metal hydride sources. By spraying titanium in the flame sprayer with an excess of hydrogen gas for combustion, I got a fair grade of titanium hydride that would adhere to a substrate and that was conductive enough to use as a cathode. The process also produced a very rough surface with many field emission tips on it. These cathodes were not the greatest, but they had other interesting properties in that they released a lot of hydrogen gas at each firing that gave the EV a really nice start.

Dog Houses

The battle to obtain stable EV sources was drawing to a close, but one thing had been noted on several of the sources that were painted or sprayed on a ceramic substrate. These sources seemed to work better when they were confined or closed on their top by a ceramic plate with a small cavity in it. This shape was an outgrowth of the mosaic technology, and had been used when I needed to isolate the plasma plume of the source from the nearby electrodes that required stable potentials. All that was needed to get the EV out of the "dog house" (as it became known) was a very small groove, perhaps 0.001 inch in diameter, cut into the lower surface of the ceramic cover.

Following this lead I started putting emitters of whatever metal combinations were to be used into ceramic nozzle structures having an outlet hole of about 0.003 inches in diameter. These nozzle sources were really great after all of the variability I had been living with. They would just churn away all day long at 2 kv and give out beautiful EVs without much plasma junk.

Mother EVs

Although I was still heavily into the question of how long the EV filaments were, I had a short interlude where I tried to answer some questions about why some of these EV shots broke my apparatus. There was a class of shot, usually running at 20 kv or so, that had been responsible for ruining a digital voltmeter that was located 3 feet away from the vacuum system, and, at another time, had blown out a power supply and pulse generator that wasn't even hooked up to the experiment. I knew I was getting strong electromagnetic impulses but this was a bit more than I was used to.

Instead of starting down in the radio frequency spectrum to look for the trouble, for some reason I went to the X-ray spectrum. I made up a little X-ray film packholder about $\frac{1}{4}$ by $\frac{3}{8}$ inches that could be put in the path of an EV so as to catch the EV on the front and, in the back, expose the film that had been separated by various filters. The film was Kodak NMB-1, a single-sided X-ray film.

The witness plate, or first plate in the pack, was 0.001 titanium so that I could verify the presence of an EV in a standard way. The second plate was an optical radiation filter of aluminum to stop any thermal spectrum coming from the back of the titanium. The X-ray film was the next layer. The film pack was exposed with an EV and then developed and checked for radiation indications. There was one black spot right where the EV had hit the titanium. So, there are X-rays.

I ran the same scheme again except that this time I upped the ante on the filtering to a 0.003 molybdenum EV target and a 0.003 lead filter placed before the film. Same result. One black spot where the EV had struck. So, there really are X-rays around here.

One more try, this time for serious stuff. I set up the scintillation detector and energy-dispersive analyzer and calibrated it with americium 241 at 59 kv and cesium 137 at 662 kv. A $\frac{3}{4}$ inch-thick piece of brass cut the cesium 137 count from 804 to 459. The scintillator was then placed outside the $\frac{1}{4}$ inch bell jar at a spacing of 4 inches from the EV source. When the EV source was fired up at about 20 kv and was running in the "sharp" mode where one could almost feel something happening, and indeed there was a different acoustical ring to the shots, the scope showed huge peaks from the scintillator output even with the $\frac{3}{4}$ inch brass plate interposed between the source and the detector. There was some electromagnetic pickup leaking into the detector, but when this was shielded out the signal from the EV gamma output was still there.

A rough calibration, based upon absorption, yielded 200 kv energies for this mode of operation. Changing only slightly the properties of the EV target made the high energy photons go away. Later we would find out a lot more about the inductance effects of this process, but for the immediate future I backed away from the hard stuff and rarely operated above 2kv. We sure enough had X-rays.

Still No Collision

After this brief reprieve at doing some X-ray work, I went back to the question of the length of a vortex filament. Having had my thinking shaken up by the mere passage of time, I was now disposed to using another collisional approach to the problem. I would try to work out a method of costreaming or counterstreaming the EVs to see at least something happen when EVs encounter each other.

It is a long and sad tale of how I struggled trying to make these little buggers run into each other, but to no avail. Mostly I required high aiming accuracy in all of the experiments I planned, and surface charge effects defeated this. I was just too far out in the woods.

On this last trip through the woods, I was able to pick up a couple of interesting tidbits that I could carry on with me. I had worked the mercury-wetted copper cathode down to 1.2 kv when operated in conjunction with 0.006 inch thick dielectric substrates. This greatly helped instrumentation that had been plagued with stray electromagnetic pickup.

Fission-Fusion

A most stunning observation was made while working on a splitter that was part of the counterstreaming EV apparatus. An EV source had been set up on a glass surface and fired at a distant anode that had another glass plate covering a part of the region between the source and the target. This glass plate was a standard microscope slide, as was the base plate, and was spaced only a few microns above the base glass, as indicated by the interference fringe pattern between the plates. When the EV was fired, and encountered the first edge of the cover glass, it spread out in a pattern over $1/4$ inch wide and penetrated under the top glass as a group of relatively straight and independent EV paths. This is amazing enough, but when these multiple paths reached the far side of the cover glass plate, they united into one EV again and went their way to the anode as if nothing had impeded them.

Think about it. Here is a bunch of little critters of not more than a few microns in size tunneling through a vast expanse of space, more than 5000 times their characteristic size, and still able to communicate to their most distant parts that it is time to emerge and then unite on the far side of the tunnel. Pretty good, for a thing that is not supposed to be smart. What I had seen here was more than a simple message. At least one phrase of the message was that these things would be watching each other, and the walls, and a lot more things than I had initially thought. They were watching with electromagnetic eyes and seeing more than I had seen up to this point. You can bet I would be watching them more carefully from here on.

The Ring Cycle

And watch I did. I set up a series of witness plate experiments to get better statistics on what I was looking at. I would fire various sources into various witness plates under various spacings and voltages. This is one of those dumb modes where it does not pay to think, just do.

I was finally rewarded with a freak shot that showed two small rings instead of the usual splash although there were plenty of splashes around too. Figure 2:4 shows these rings.

Magnified views of the rings are shown in Figure 2:11 and 2:12. The background material within the center of the rings has not been disturbed much, an interesting clue as to the shape of what struck the surface. Why there were only two of these things is beyond me, but thank goodness for them. I think this was my break. I could see a long quest coming to a close.

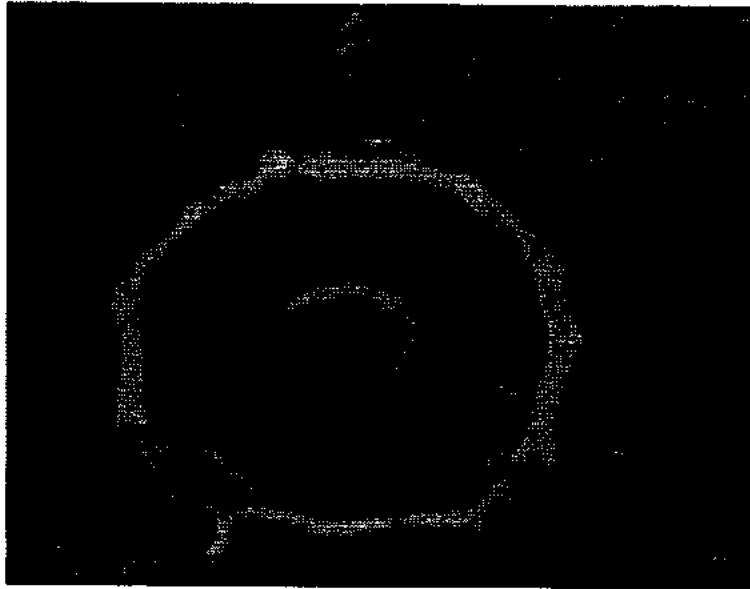

Figure 2:11

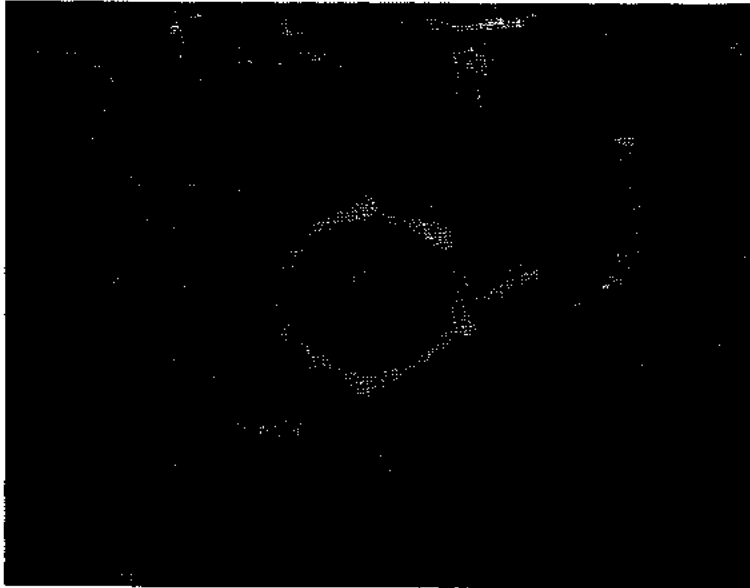

Figure 2:12

It was time to get very serious now about this length problem. I was sure that if I could set up a stream of vortex filaments from the source and electrically sweep them across the target I could surely cause them to show some streak effect that would indicate their length. To accomplish this, I used an EV source that shot across a region of glass, coated with high-resistance material to control the charging. A deflector scheme was worked out to couple part of the rapidly falling voltage of the source, which occurred when the EV was initiated, to the resistive region the EV had to traverse. The witness plate at the end of the run was spaced a small distance from the plate the EV ran on, and in this case it was made from a film of aluminum on glass.

After the EV source was fired one time, the witness plate was taken to the optical microscope and examined. The pattern was interesting but not very clearly resolved. I do not have a very good optical microscope. The sample was carried to the SEM and it was clear why the optical image was not easy to figure out. Most of the area struck by the EV was blown away and the aluminum that left with the micro explosion carried some glass with it.



Figure 2:13

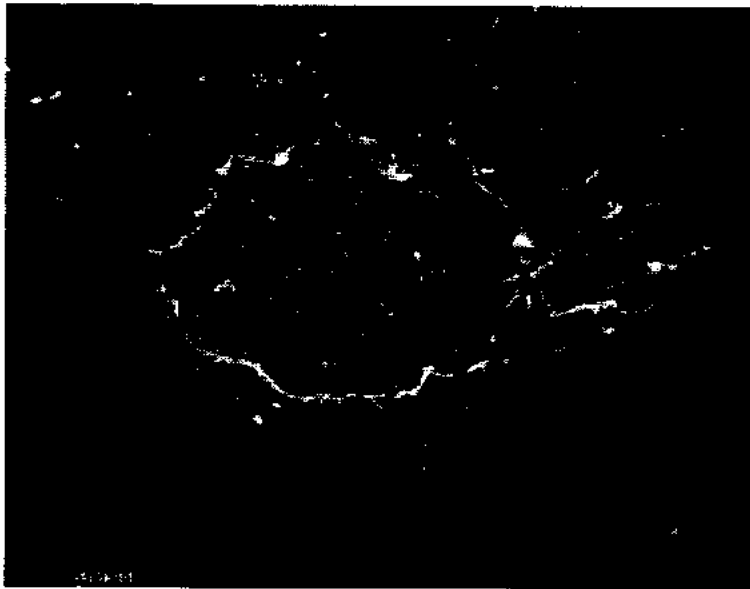

Figure 2:14

Figure 2:13 and 2:14 show what I saw. A little bit of a mess, but basically I was on the right track. The top center portion of Figure 2:13 has several clear marks that are in the one micrometer range that were not energetic enough to destroy the surface. Figure 2:14 has some beautiful decoration on the substrate, possibly stemming from the pressure wave pattern of the explosion.

On Target

Next, I prepared some targets, witness plates, from a fairly heavy evaporation of chromium-carbon on glass. The notion here was to provide a material that would rather sublime than melt. This should improve the resolution of the witness mark because most of the resolution had been lost through melting effects.

A 5 kv shot was fired, the target examined in the SEM, and the vortex filament theory was dead forever. Long live the bead! There was no length to the charge structure at all, save that of its own diameter. The basic carrier of the charge was a bead, one micrometer in diameter, and the beads formed chains. These chains would hit a surface square-on without rotation, translation, or skewing.

Figures 3:1 through 3:6 (in the next chapter) show what these beasties really look like. They are not morning glories; they are not vortex filaments; they may not be vortical at all. At this point I imagined they were microscopic packages of pure charge having the density of a solid, possibly being held together by an unseen container of radiation stemming from the vacuum, that exalted plenum of energy we might hope somehow to tap.

Chapter Three

TOOLING UP AGAIN

It was December 27, 1981, when the bead data came in. Although it was two days late, it was one of the best Christmas presents I could have asked for. Such little gains in data greatly intensify my urge to go on, but, I have learned, they also provide me with a great deal of guidance about how to open up other routes. I am sure I spent some time reflecting on the routes we had abandoned, as well as some that had not quite been started, but none of this was in my notes; everything was about the beads.

A Look at Beads and Chains

In addition to showing that the EVs were beads in a chain instead of a filament structure, the photographs clarified some of their other properties. The chains always hit flat on the witness plate, and ellipticity in circular chains was largely due to the 45-degree viewing angle in the SEM. These chains appeared to be spaced through time, and they would most likely be found as a stream of chains in vacuum flight, one behind the other.

There was also a similarity of chain diameters in any one particular shot. The beads were somewhat quantized in size, although a few detached beads could be found that were apparently smaller in size. Stray beads were hard to find; they were mostly grouped within the available rings.

Chains Unwrap

The most striking characteristic of the bead chain was its impossibly complicated tangle that somehow knew how to straighten itself out. The photographs in Figure 3:1 through 3:6 show a shot that had been given a vacuum jump of about 1 mm between the launching glass surface and the witness plate. This vacuum jump allowed the chain to begin to unwrap from its previously tangled state.



Figure 3:1



Figure 3:2

This appears to be an analogue of the familiar pull chain for a light, or the old bead chain on the plug for the bathroom tub. Such a bead chain would tangle when thrown across the floor, but would unerringly straighten out when picked up. I do not mean to imply that there is an actual untwisting occurring, but rather that the nodes of a complex pattern are somehow moving.

Many amulets (the pendants that hang off the chain, as seen clearly in Figures 3:2 and 3:6) worn by the EV chain are still unwrapped in Figures 3:1 through 3:6, but the chain is many orders of magnitude more pristine than the one shown in Figure 3:7, although the latter is also an EV chain.

Sweep Indications

The heavy concentration of EV strikes in the center of Figure 3:1 produced so much strain in the witness plate film that it was cracked and detached from the substrate. It was the intent of this experiment to sweep the group of chains along the substrate by applying a deflection voltage to the region between the EV source and the witness plate. In the photo in Figure 3:1 the sweep was supposed to be from right to left. It appears that something like that happened.

Figure 3:2 is a continuation of the sweep and was found immediately to the left of Figure 3:1. Presumably, the nose or front end of the EV train arrived in Figure 3:1 and the tail end of the shot came along in Figure 3:2. As is usual for the kind of strike shown, there is a quantity of molten material scattered around the surface. There is a fair correspondence between the amount of molten material found and the destruction on the surface. In some configurations it is possible for cathode material to be carried over to the anode witness plate.

Few Wandering Beads

Figure 3:2 shows several interesting things. The strike immediately at the end of the crack in the film shows many radial marks that are, more than likely, unopened portions of a chain. The center is well developed into a circle. Allowance must be made here for the 45-degree viewing angle of the SEM that tends to produce an elliptical appearance for perfect circles. The circle immediately to the left of the crack end shows a very nice circle, but for

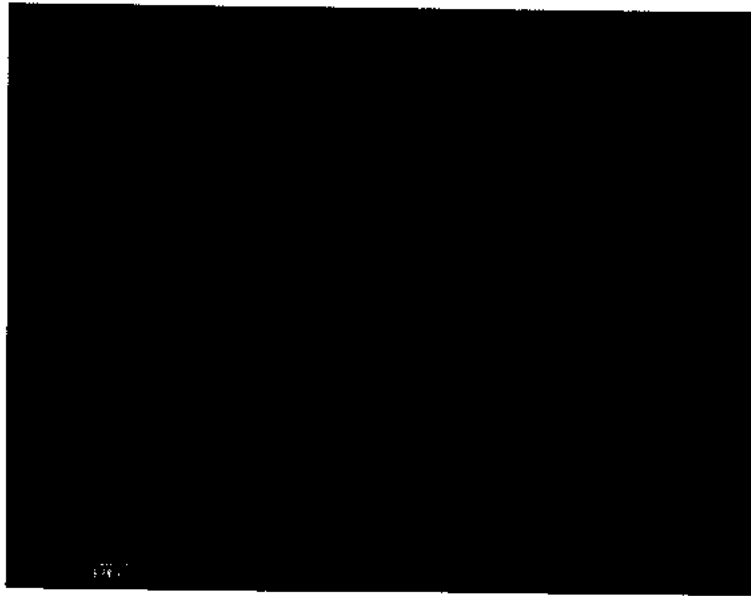

Figure 3:3

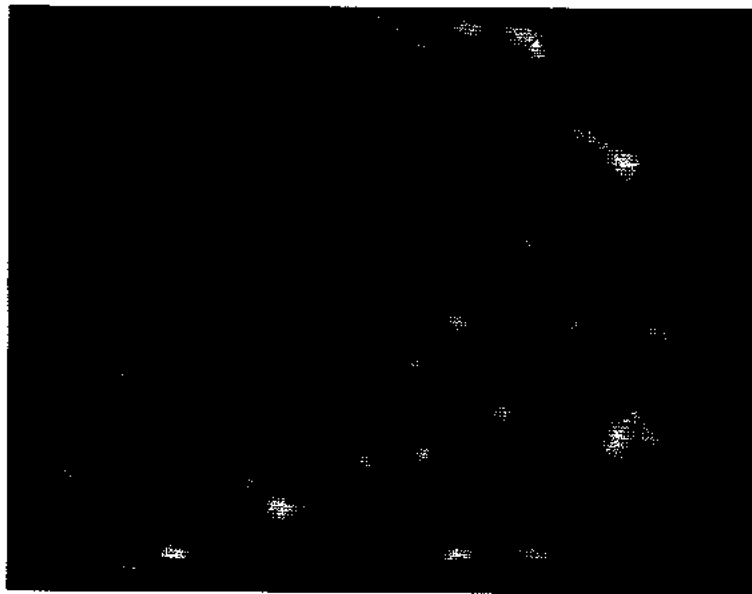

Figure 3:4

some reason a disordered group of beads extends downward from the circle. Higher magnification shows that this group is attached to the circle. This same circle shows a few disconnected beads in the center of the circle but none are to be found outside of the circle. This is very common for a highly ordered EV shot such as this. Randomly placed beads are rarely found.

High Surface-Energy Gradient

Near the center of Figure 3:2 there is a small circle of beads that is shown magnified in Figure 3:3. One of the interesting details of this photo is the clear region that exists between the beads. There is not enough energy available to even lightly disturb the surface. Again, there are two beads in the center of the circle that are seemingly detached from the rest. In this photo there is an opportunity to assess the size of the beads that were presumably made under similar conditions.

I have been telling myself that there is some force tending to make beads having a diameter of one micrometer. This is not strictly so, as can be seen in Figure 3:3. There is a tendency to average around one micrometer in diameter but a lot of vagaries exist.

Figure 3:4 is a magnified view of the top center bead shown in Figure 3:3. The thermal process that produced the crater has seemingly destroyed any detail the EV may have had. All that results is some pressure wave pattern or flow pattern for the film material. Handbook data on chromium states that a pressure of at least 10 atmospheres would be required to produce the effects of melting shown in the photo. All that can be said for sure is that there is a very high energy gradient at the surface.

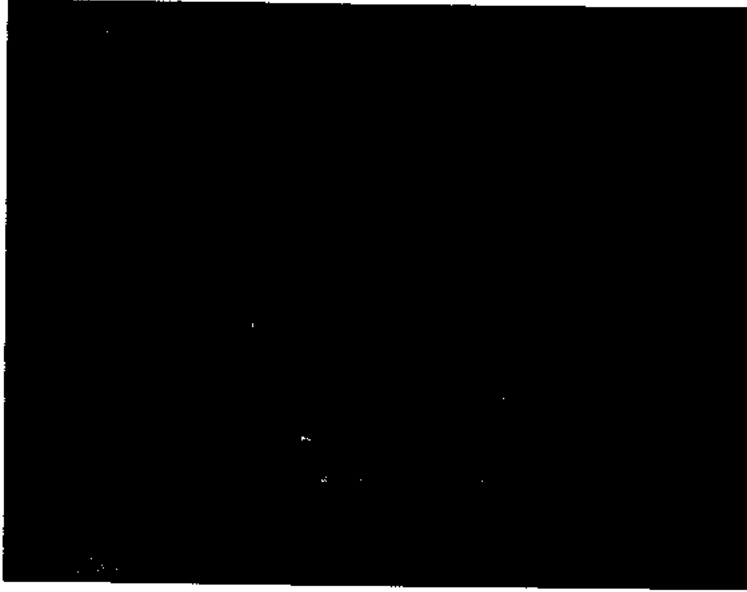

Figure 3:5

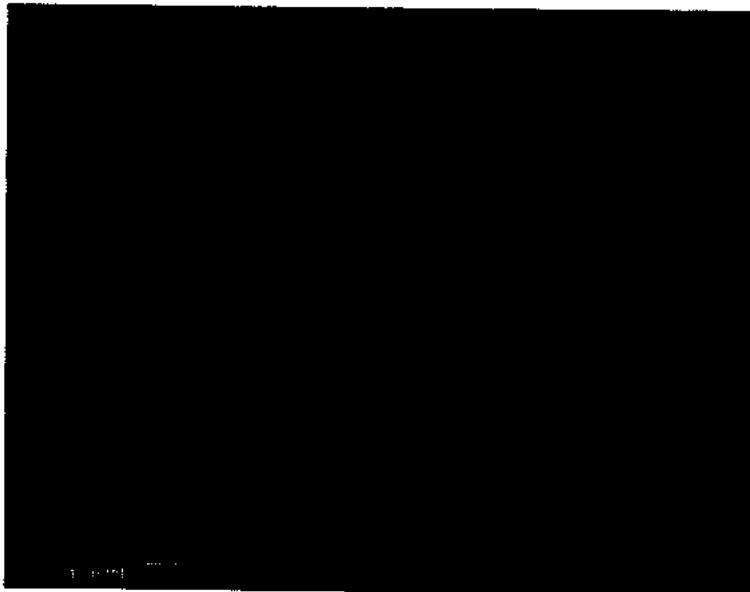

Figure 3:6

Figure 3:5 is an example of another intermediate stage of opening where the amulets hanging onto the main structure are fairly complex. Perhaps by looking at this intermediate state someone can figure out what the actual process is that is forming this shape. A few beads are shown within the circle and some very heavy metal splashes are shown coming from somewhere near the top right of the photo.

Figure 3:6 shows a more fully developed chain opening. Notice in this photo how the background is clear of damage and how the free beads are located entirely within the circle.



Figure 3:7

Figure 3:7, also an EV chain, is a 1500X darkfield optical microscope image of an EV shot that was caught near the launching glass plate and had a very short vacuum flight. Possibly this is how messed up an EV chain gets when it is being dragged along a surface. There are literally hundreds of beads in this chain and they are hanging onto their order for dear life while being beat on the surface, ionizing gas, and screaming along at one tenth the velocity of light. The binding energy of the beads apparently exceeds that of the material they are beating up at the surface. In the lower left corner of Figure 3:1 there is also an errant tangle of beads that failed to straighten out as much as the others in the same photo. This tangle was put on in a previous shot as a marker of where the next shot having the vacuum flight was supposed to begin.



Figure 3:8

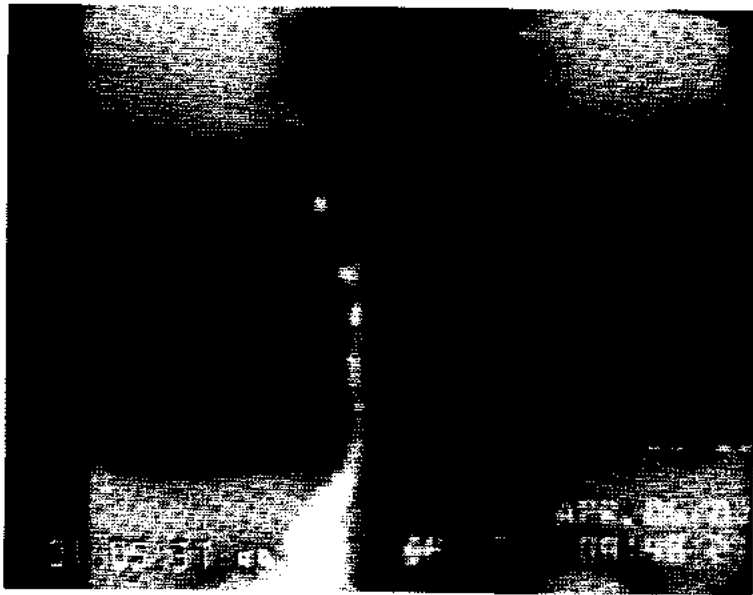

Figure 3:9

Vacuum Arc on Surface

Figure 3:8 and Figure 3:9 are video camera photographs of a typical vacuum arc running across a surface. The surface is prepared by coating two ceramic plates with a 1000-ohm-per-square resistor material in the region shown in black. This coated region on each plate is about 1/4 inch long. On the top and bottom of the coated region a silver layer is also fired onto the ceramic adjacent to the resistor material, and these terminals serve as cathode and anode for the test. The two plates are separated by a vacuum gap of 0.01 inches, thus causing the discharge to jump across the gap to the other plate. The entire apparatus is operated in vacuum and a direct current voltage is applied to the electrodes, with a suitable series resistor, and raised until, at about 10 kv, a spark is initiated.

A variety of things can be seen in the many video frames obtained. Almost always, the discharge comes from the silver electrodes, and rarely from the resistor material, although occasionally field emission can be seen at the edge of the resistor at the gap. This is shown as a small light spot in Figure 3:8, just to the left of center at the vacuum gap. The width of the optical image is much larger than the damage mark left on the surface. A discussion of this damage effect follows.

By varying the resistance of the coating it has been found that the relatively small EVs used here are able to run on surfaces as low as 200 ohms per square but no lower. Below this value the EV is destroyed much as it would be on a metal surface. Even when resistor-coated surfaces are used, the EV will not run in a straight or predictable path, and so it is assumed that something other than the charge on the surface is controlling the path. Often an imperfection can be seen blowing up just as the EV takes a turn. It is hard to make a surface free enough of imperfections to entirely eliminate this effect.

It is my contention that an EV group starts at the cathode, runs across the surface of the dielectric or resistor material, jumps the vacuum gap and proceeds on to the anode across more resistor material. This is a truly virtuoso performance for such a little fellow.

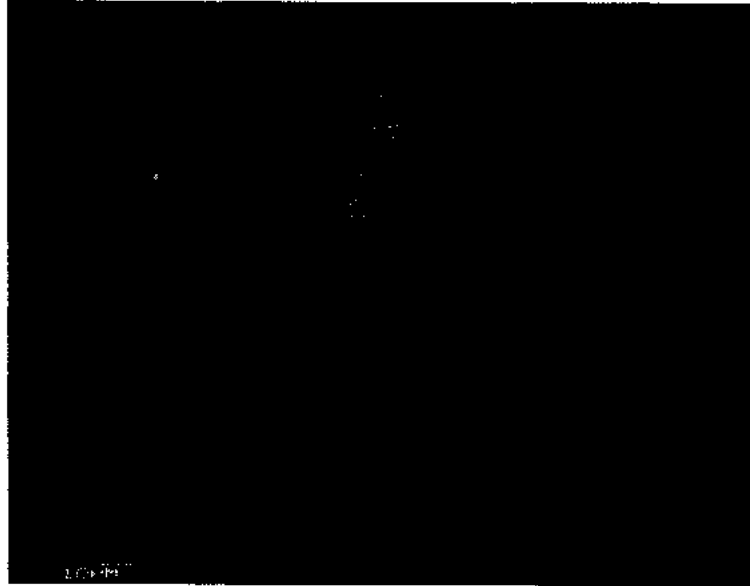

Figure 3:10

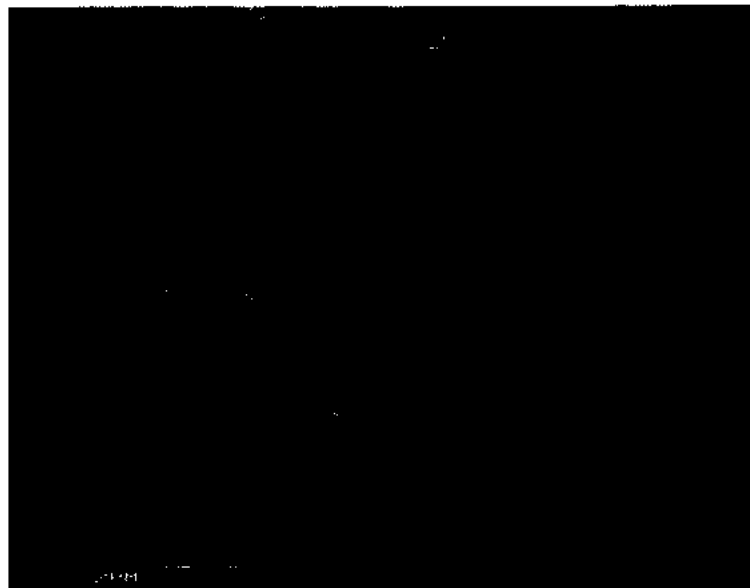

Figure 3:11

Hopping EVs

Figure 3:10 and Figure 3:11 show a SEM shot of the trail that was left behind when an EV ran across a surface. A surface of glass was very lightly coated with aluminum by thermal evaporation and a negative voltage was applied so as to repel the EV. I had learned that this negative voltage gradient was bad news for EVs and would destroy their order if propelled against the field in a particular way. What you are seeing is a group of EV chains bouncing along the surface, biting out small hunks, breaking themselves up, and then, at times, fusing back into larger entities. One interesting characteristic of this action is the almost equidistant nature of the jumps. Big boulders jump a long way; small rocks don't jump so far. This skipping and hopping gives a clue as to what the damping forces are.

It is not entirely obvious from the photograph that the EV is really hopping off the surface. What shows is just regions of non-destruction and this could be caused by something else. I am getting ahead of myself slightly, but I will tell you now that an EV can be gently lifted from a surface and will fly along at any desired height without touching a thing. That is why I say they are jumping in the photograph. There is more discussion of this later.

No Field-Free Regions

Now might be a good time to pause from our technical flight and consider some of what was going on with my thinking at this time.

I had a fair background in reasonably standard gaseous-discharge and particle-optics work, and all of that now seemed wrong. This bothered me a lot because such massive bodies of information are not wrong very often (give or take a few witch hunts and inquisitions). At this point I had tried mightily, and would try some more, to put EV-like things through standard electron lenses, quadrupole containers, and spirupole filters. They just would not go.

I felt like I was a little boy again, trying to stuff our big old yellow tomcat through the small hole in our underground cistern. It just could not be done. I could not get the EV past a single aperture in a particle optics system. Had I lost my mind or something? Were these things massless? What happened to the inertia that is supposed to carry them along in a field-free region?

Aha! There are no field-free regions around an EV. This intense, moving-charge entity works electrodes over so thoroughly, coupling to everything, that the voltages I put on them

are almost inconsequential. It looks like all the old rules may be OK, but I would have to move the goal post a little to accommodate this new kid on the block. This new kid is the proverbial 800-pound gorilla and he is going to do pretty much what he wants to do.

The scientific reader is probably wondering how I knew what the total charge and charge density was. I certainly have not given any measurements thus far that would tip that fact. Please be patient a little longer; I will get to that.

Mainstream Considerations

There was another matter that kept me awake a lot, and that was how to fit this new-found EV data into all of the standard arc, spark, and glow-discharge work. The new data, or at least my interpretation of it, seemed very much at variance with most mainstream considerations. Worst yet, suppose they were right with all of those leader, streamer, return current sheath arguments, and that there were really no EVs at all, but just some form of continuous flow process that miraculously necked down at the witness plate to deposit its energy? OK, if that is so, I would take this process and work with it too.

Seriously, at one point in this project I could take any 50% of the data I had, and with it I could not prove or disprove the streamer notions. We hired consultants, and we argued mightily among ourselves as to where the true course of requisite lay, but in the end the guidance came from the gentle hands of Bill and Hal, who said something like, "Come on down the path; it's better over here." I might have turned back had it not been for this help. If someone had just once seriously suggested we make a whiz-bang and sell it as a money pump, that would have been the end of the journey to EV-land. We were very delicately balanced.

What Can I Make Them Do?

Enough of the psychological worries that went on during this time. Let's go back to the technical considerations. This second pass at tooling-up was going to emphasize seeing the electrical properties of the EVs, instead of just creating them. Of course there would be some sideways motion that would be concerned with generating and detecting them in different ways. This sideways exploration is inevitable with me, but is a good thing to do anyway at such a primitive state in a project.

I could take the view that Thomson must have taken when he discovered the electron--"To heck with what it's made of; let's see what we can do to it." The instruments in this phase of work would have the characteristic of analyzing the actions of the EV under different conditions, with the aim of eventually controlling all of its actions.

There were some large hurdles to overcome at this point because I had not been able to put an EV through an aperture into a field-free analysis region, one of the most fundamental requirements for conventional particle analysis. I could handle them somewhat on surfaces and guides, but the confinement was so tight there was no way for weak external measuring forces to sample their properties in the presence of this containment "noise." I was destined to try a lot of silly-looking things in an attempt to inject EVs into a measuring region.

Lossy Mirrors

The first of these schemes for injection was based upon using highly dissipative materials for the particle optical elements. I am not really sure where the idea came from, but I already had the notion of how an EV traveled on a resistively-coated dielectric surface. I imagined the surface to appear positive to the EV and that it would be attracted to such a region just ahead of it. As soon as the EV reached this positive point, it would effectively neutralize the point with its negative charge and the positive looking point would move ahead to further induce the EV to go that way. I am sure this scheme does not really hold water but I built a lens structure out of graphite and shot an EV through it. It wasn't much of a success because the hole had to be much larger than I wanted, and the EV struck the graphite lens element on the back side, but it was better than I had been doing.

I tried to plot the trajectory of the EV behind the lens in a kind of left-handed fashion by using witness plates at various spacings and voltages behind the lens element. I could collect the EV on the witness plate under certain conditions, but for the most part the system was acting like a very divergent mirror. It looked like the EV was inducing large negative fields on the electrodes and then responding to this field, just like the book says. Dissipative structures helped some, but did not leave me with a good feeling. I dumped the effort.

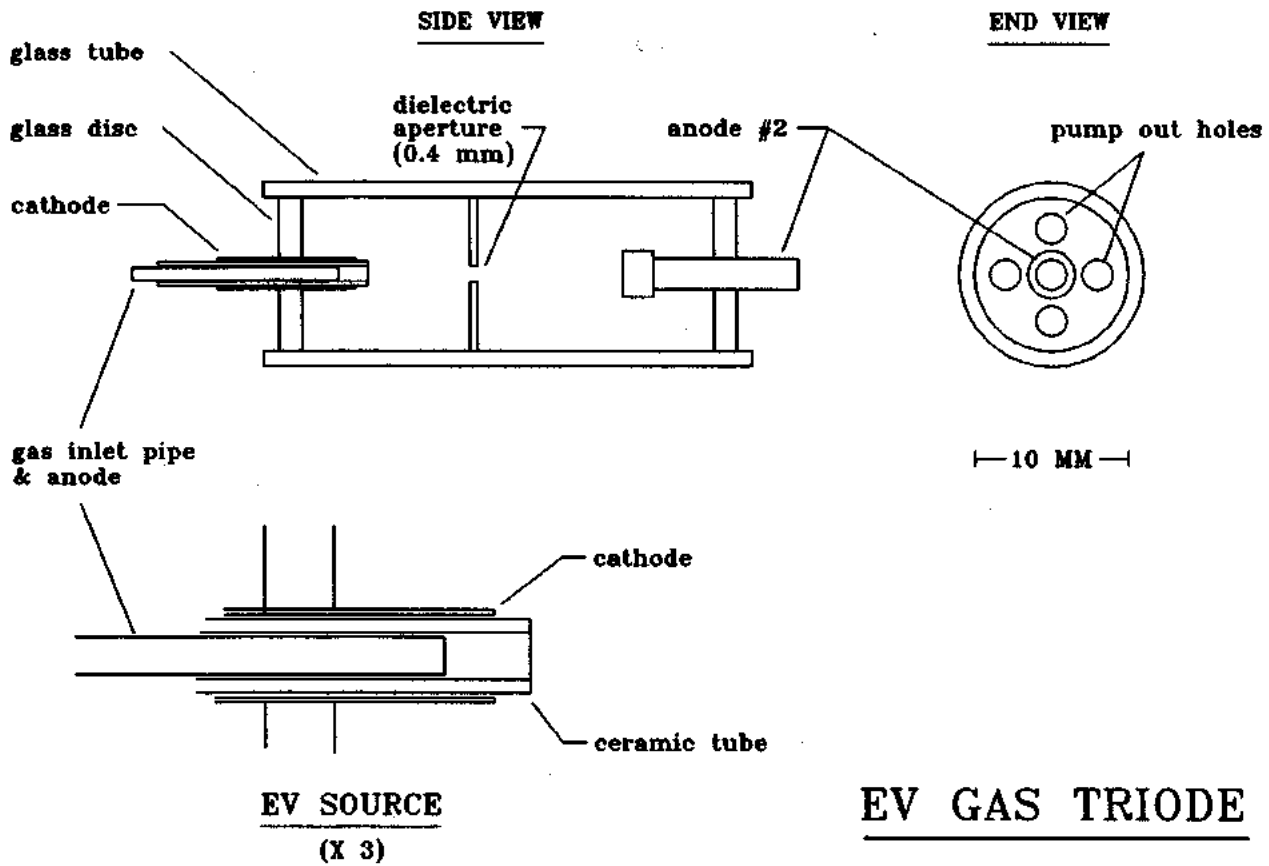

Figure 3:12

Gas Guns

In an entirely different approach to injecting EVs into a vacuum region for measurement, I built a gas triode similar to the one shown in Figure 3:12.

The entire apparatus was operated in a vacuum chamber pumped by an oil diffusion pump. The EV source was operated at a sufficiently low hydrogen gas pressure, perhaps 10^{-2} torr, that there was no gas discharge when several kilovolts were applied to the cathode. At a slightly higher voltage the cathode would fire off an EV and, with a positive voltage applied to anode #2, operating in near-vacuum due to the aperture plate and differential pumping, the EV would strike the center of that anode.



Figure 3:13



Figure 3:14

Figure 3:13 shows an SEM photo of the removable witness plate that served as an anode and Figure 3:14 is a magnified view of the center region.

These look like standard strike marks that can be obtained by almost any method. Considering that the anode was over 1 inch away from the source, and that the entire shot group, usually fired one at a time, was only about 200 micrometers in diameter, I was surprised by the consistency of such a random-looking process. The pressure adjustment was very critical, and this was not the kind of beast I wanted to incorporate into a complex system of measurements. Why did I do it? I don't know. Maybe I just wanted to get one of these things through a hole under any conditions. As they say, "Onward, Through The Fog."

Storage?

There was one very interesting effect that showed up with a slight modification of the apparatus (Figure 3:12). When anode #2 was changed from a plate to a wire about $1/64$ inch in diameter, and the signal voltage on this wire was fed to an oscilloscope, there was an alternating current signal hanging around for nearly 100 microseconds after the EV pulse was terminated. It could have been just the usual gas vagaries, or it could have been an EV orbiting the wire in wildly different orbits. This is a known stable mode for a short time for both electrons and ions. I really didn't think of this while I was doing the work, and I couldn't afford the time to go back and check.

Coaxial Diodes

It seemed to be time for another one of my digressions into EV formation, with the intent of getting more specific about the energy needed to form them. I set up a coaxial structure similar to the one shown in Figure 3:15 with the center electrode movable between a charging electrode and the discharging electrode. Both surfaces in the discharge region are removable hemispheres that could be highly polished before discharge, and put into the SEM for examination after discharge. The line impedance was about 50 ohms and both a 5-inch and a 1-inch line length were used at various voltages to form the EVs. The discharge is obtained by first moving the line center conductor to the charge position and then carefully moving the two hemispheres together until the spacing is small enough for breakdown to occur. Figure 3:16 and Figure 3:17 are photographs of some of the shots taken on titanium electrodes.

COAXIAL LINE EV GENERATOR

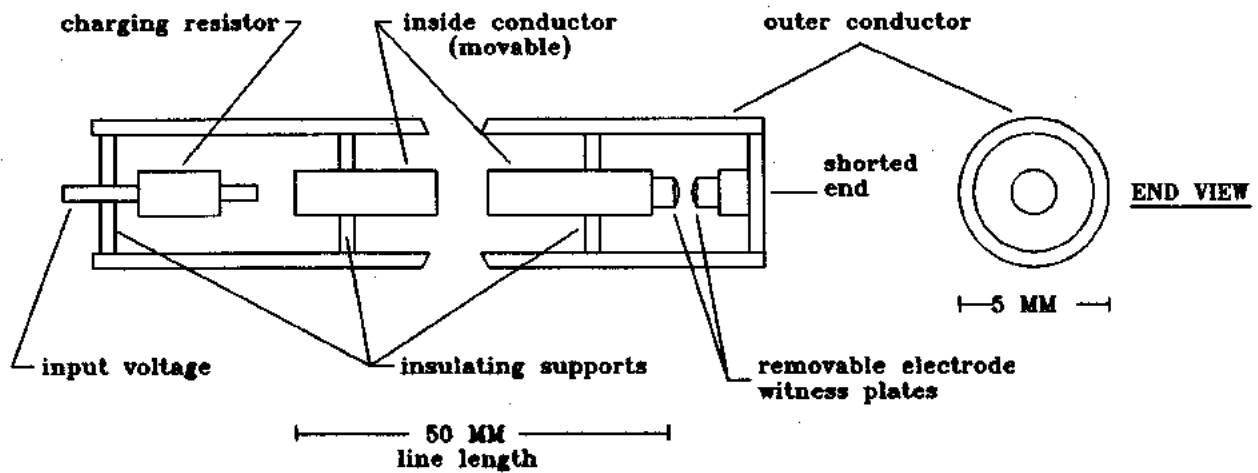

Figure 3:15



Figure 3:16

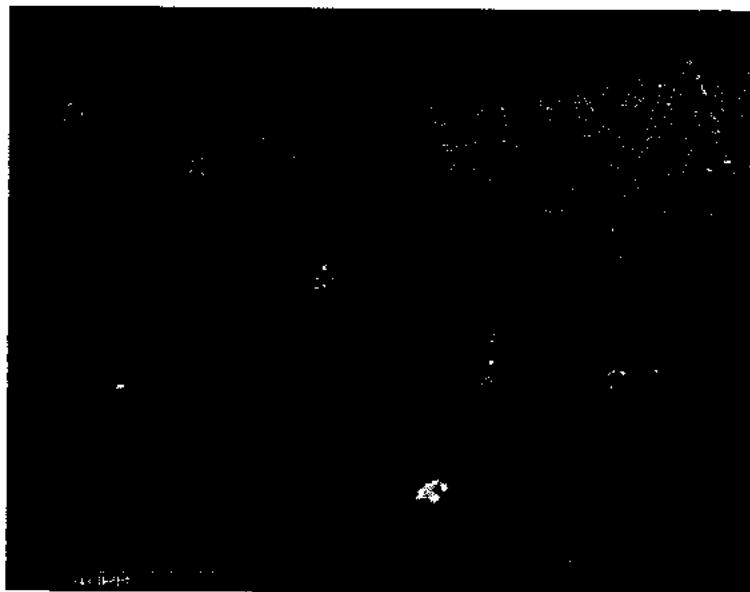

Figure 3:17

EV GAS DIODE

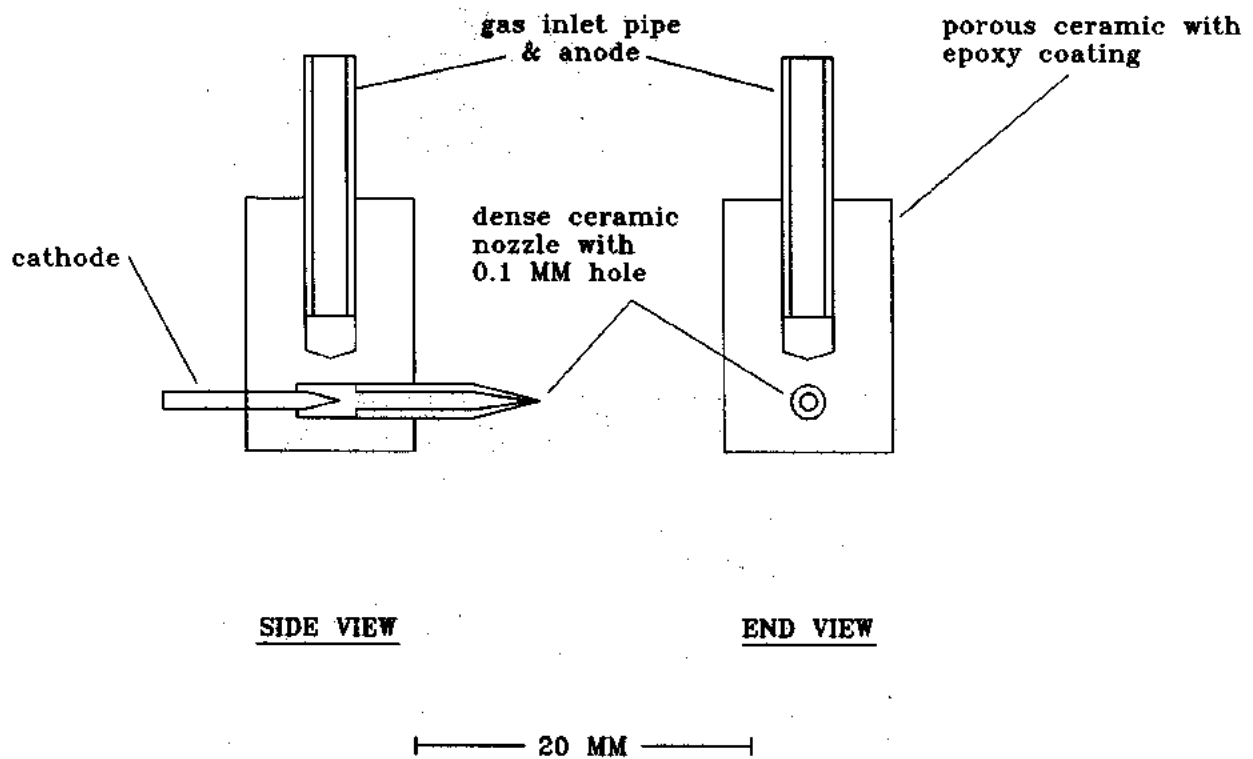

Figure 3:18

The most obvious patterns in the photos are the concentric rings with a really wiped out center. The energy in the center is so high that all EV data is wiped out by melting. In the circles just outside of the melted region there are many of the morning glory patterns showing. In fact, there are far too many patterns showing for me to assess anything about the energy for EV formation even at the lowest voltage used, 1 kv. It was found that the concentric patterns are due to the curvature of the surfaces, and are undoubtedly related to the pressure waves of vapor coming from the electrodes. This is just another ill-fated experiment when it comes to gathering significant EV data.

All of these little bits and pieces of the puzzle, although not strictly related to the problem I was working on at the time, were adding up to become significant tools. An example of this follows.

Enter the Black EV

While working on the gas triode shown in Figure 3:12, many unanswered questions had come up, but the EV source itself was an interesting one. In order to investigate some of the properties of gas sources, an EV gas diode source was fabricated similar to the one shown in Figure 3:18.

The nozzle had a 0.004 inch diameter hole in the tip end and a copper wire in the large $1/32$ inch diameter end. Hydrogen gas was fed into the nozzle by using porous ceramic between the feed line and the nozzle. The feed line was grounded and acted like an anode, but the porous ceramic prevented direct bombardment of the anode. The entire structure was operated in an oil-diffusion pumped-vacuum system. At this point in the project I introduced a real pulse generator instead of my old faithful mechanical vacuum switch. I didn't get too fancy, mind you; I used an old capacitor discharge ignition system out of a car. The pulse was pretty awful, 80 microseconds or so in duration, but it stopped direct-current glow discharge when working with low pressure gas and that was the main reason for going to a pulsed voltage.

In use, the tip of this gas EV source was made to touch a substrate at a very acute angle aimed in the desired direction for propagation of the EV. One thing noted immediately was that this source launched "black EVs."

Whatever came out of the nozzle was not optically visible (unlike the usual case), and the EVs would travel a long way compared to the vacuum case. Apparently running in a low gas pressure was much less lossy or interactive than even the vacuum case. In the triode device (Figure 3:12) this was also the case, as an EV was never seen in the region having a low hydrogen-gas pressure. Witness plates were used to verify the existence of EVs and every shot was the real McCoy. In designing this type of source I imagined that I could simply stick it into any apparatus that had adequate pumping speed to produce the desired level of vacuum and the injection problems would be over. Not quite, I just moved the problem back one aperture.

An Unusual Breakdown Mode

Life with the EV was a tumultuous experience. None of the good old rules worked. Once in a while something really off the wall showed me what I was up against.

In one experiment with the gas diode EV source, I had occasion to use a small Formvar-insulated wire as the second anode to collect EVs. The wire size was perhaps $1/64$ inch diameter and insulated with heavy Formvar. I do not usually use Formvar in vacuum but I was in a hurry to do something and grabbed it. When the EV was fired at the wire with only low voltages applied to it, nothing especially interesting happened. At a very critical threshold of 4.8 kv applied to the wire, all hell broke loose. At every EV firing there were showers of sparks from all along the Formvar-coated portions of the wire. The regions that had been stripped were unaffected. The Formvar was being exploded from the wire, and later examination of the wire under the microscope showed highly disrupted regions that had been torn off. Wow!

I have spent a lot of time tinkering with field emission processes and have seen such blowups often, but always with direct current applied to the electrodes. This one did not figure, so I went back to test the wire under the same conditions at high voltage direct current, but without the EV present. I put both plus and minus 30 kv on the wire (all my feedthrough would allow) and nothing happened. I gave up on the mystery at that time, but I have since concocted a couple of theories. One of these theories is that the charge dumped on the line raised the field at the wire surface so rapidly that the surface of the insulation, in spite of the high dielectric constant, lagged behind and appeared positive enough to promote field emission from the wire cathode. Another similar theory is that the intensity of the wave traveling on the wire was high enough to promote field emission and breakdown in the longitudinal direction, somehow invoking the dielectric as a waveguide boundary. Whatever the cause was, this was an intense process at work, and is an example of everyday life with the EV. At the very least, another small tool has been added to the box.

Some Black EV Laws

What about those observations on black EVs? Could a little light be shed on this? It looks important. Is it just lack of visual radiation or does it include all frequencies? A low-loss process is always interesting.

To get at these questions, and more, an experiment was set up having a gas gradient away from a surface, while at the same time causing an EV to be launched in the highest pressure region of the gas.

GAS EV GUIDE

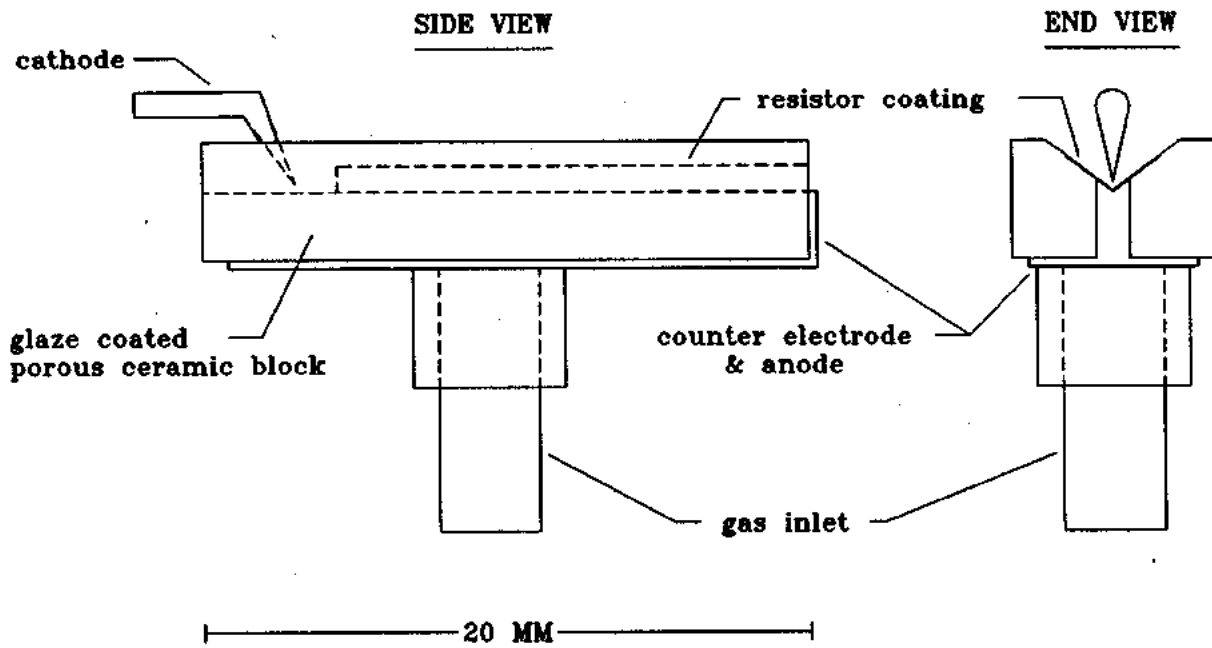

Figure 3:19

Figure 3:19 shows a sketch of the layout used. The gas is introduced into a block of porous ceramic that has been covered everywhere with a non-porous glaze, except for a tiny scratch in the bottom of the groove. A resistive glaze is used in the bottom of the groove to help dispel charge. The gas comes out of this groove and is pumped away by the vacuum system, thus giving a pressure gradient. The EV source was a mercury-wetted copper wire that lay in the bottom of the groove and used the counter electrode as an anode operating at ground potential. A negative voltage pulse of about 2 kv is usually applied to the cathode when the emitter is sharp, otherwise a higher voltage must be used.

This little gadget just described was operated under the view of a microscope and some interesting details could be seen. If the unit was pulsed without any gas in the channel, and with a collector electrode at a large distance for the voltage applied, there would be no EV formation. This is a condition we have called "flaring." Under such conditions only a plasma plume is created at the cathode and no EVs are formed. I had become so respectful of the EV that I had created a mystical phrase saying "If you don't give them a place to go, they won't start." This personification is not entirely without merit, because it will be shown later that there are advanced electromagnetic messengers sent out from the source to determine if the environment is correct for formation and propagation. EVology has a lot of new rules.

When the anode is correctly positioned, and the gas pressure is off, the path of the EV is fairly short, and definitely tortured, as evidenced by the large amount of light given off from surface interaction. As the gas pressure is raised, the light from surface interaction dims out, and the distance the EV will travel to the anode increases greatly. Under the microscope it can be seen that the EV has been raised above the surface. The lifting is most evident on rough surfaces where the tops of protruding ceramic bits are attacked by the passing EV. As the gas pressure is raised further, the EV is lifted above the protruding obstacles. This is a rather amazing process to watch but it is absolutely dependable as if the surface had been greased with a magic substance. I had been accustomed to using highly polished surfaces for EV guides but even the roughest surface had low loss with gas.

In addition, even the customary fluorescence from the surface was absent with gas. This was indeed a high degree of isolation and the EV path is very black. I have not accurately measured the gas pressure, but it was below the value that would promote a direct current glow discharge between anode and cathode when several kilovolts were applied. An estimate would be in the 10^{-2} to 10^{-3} torr range. Another interesting new tool has been added and, although it does not entirely explain the behavior of the more complex gas triode described earlier, it helps.

Back to Wideband Scope Design

It was clearer to me as time went on that the need for a fast oscilloscope was just as great now as it was in the very beginning. In fact, I had done myself a great disservice by plowing on blindly when assessment of rapidly varying fields would have possibly solved many of my problems. This was clearly one of those hinge points in a project where a correct decision will go a long way and it behooves one to regard carefully all moves at this time. I needed an oscilloscope with a bandwidth of perhaps 100 GHz and a sensibility of around 50 volts. I could forego input attenuator switching and highly adjustable timing for sweeps. I was certain that with the implied bandwidth I would not be able to carry the signals very far on cables, and so the scope would have to be a small chip structure located close to the experiment. When these and other considerations were factored into the decision of whether or not to start a major instrument program, I have to admit it looked like a real fight was in the offing. Should I go around this one or hit it head on?

Bootstrapping

I was beginning to use the tools I had accumulated on this project, and apply them, even in half-finished form. A bootstrap operation was in effect, and EV techniques were beginning to reveal answers about new EV questions. This had become necessary because of the increasing gap between the use of conventional techniques and the emerging EV technology. As an example of this trend, the cathode for the scope was going to be a special adaptation of one of the EV sources, because it had higher brightness than anything I had ever seen before. There were other problems, but perhaps they could be handled within the tolerant bounds needed for the scope cathode. EVs were looking like pretty good things, and I was confident I could make good use of them.

The Picopulser

As with all oscilloscopes, there was a need to synchronize several signals without jitter destroying the time resolution of the instrument. What this would mean in EV technology is that one EV must trigger the generation of another without jitter. I did not know the details of the formation process, and so a little test was in order to determine some of the birth parameters. To do this I set up a test whereby an EV target was connected to the cathode of another EV generator. A bias voltage was applied to the second EV generator so as to test the operating point of the field emission process connected with EV generation. In operation, this bias voltage was set to some value and the primary EV pulse fired. Then the

second cathode, or EV source, was tested with a witness plate to see if an EV had been fired from it. This primitive device was a pretty ragged performer, but it was finally developed into the picopulser, or EV pulse generator, and into the field-emission EV sources that are described in the chapter on Components and Devices.

Thick-Film Work

As is usual in backing off to make a special piece of apparatus, I also had to keep backing up into the construction technologies. This time I needed a high temperature equivalent of the commercial thick-film screening process for firing patterns of materials onto ceramic substrates for producing conductors, dielectrics, and resistors. In order to avoid many of the known limitations of conventional thick-film processing, I elected to develop a vacuum firing process. A vacuum furnace was built capable of firing a 1-inch substrate to over 1800 degrees centigrade for maturing the various concoctions applied to it.

Within a short time I had brewed up the materials I needed. Conductors were mostly molybdenum with a pinch of aluminosilicate glass for binder. Dielectrics were aluminosilicate glasses and resistors were aluminosilicate glasses with a pinch of titania reduced during the vacuum firing. I could use this combination of materials, along with the mosaic technique, to fabricate almost anything I needed for the scope project. Once in a while the surfaces were too rough and I had to polish them or use an evaporated coating to do the job.

Cathode with Strings Attached

The cathode for the scope turned out to be an EV source of the mercury-wetted copper type, followed by another aperture to isolate the plasma and define the emission angle more accurately. This design flies in the face of conventional design. It used ceramic in regions of electron flow that are normally held sacred for metals only. There was no charging problem, and so I did it. Charge was taken care of as if by magic.

The average emission spectrum was measured by projecting the emission image onto a fluorescent screen through a deflector-type energy analyzer. It was horrible; I didn't worry about that. I only wanted the emission to have good spot shape and low energy spread during a short period of time, and I could provide for that with a fast gate. The emission was too bright for the phosphor screen, and so I put in another aperture, in the form of a pinhole, to help clean up the image. I was about to make an important discovery.

Even though I had threatened to make a pinhole electron camera over a year ago, and had even bought the channel plate electron multiplier for it, fate had kept me from putting the entire apparatus together. I had initially wanted it to look at black EVs and see if there was anything in the way of electrons coming off of them. I expected there would be, but there were other things to do. In effect, I had now made a crude electron pinhole camera and was looking at an electron source that had an EV for its origin. I puzzled over what I saw, because it looked like there were stringy things coming from the source, and not the smooth emission I had expected. Something was amiss. This was one of those wild moments I live for. There was a new animal in the woods; I was looking at it and it was looking at me. What to do?

Now here was a tool and a half. With this, in cleaned-up form, I was going to be able to bring down a mighty blow upon something. The cathode work was folded up in a neat package and put away, with many thanks for this introduction to a whole new world. I was off to make a better electron camera, and see what this stringy new stuff was.

The Pinhole Camera

A pinhole camera was thrown together according to the drawings shown in Figure 3:20, and the photos shown in Figure 3:21 and 3:22. This is an extremely simple device, as scientific instruments go, and it has performed admirably from the beginning. What is not shown on the drawing is the arrangement of the power supplies that allows nearly any voltage to be applied to nearly anything. A bunch of unregulated and isolated power supplies were used. These power supplies had reversible output polarity and could be stacked in almost any imaginable arrangement. With this power supply system the voltage on the phosphor screen could be maintained at 5 kv relative to the output of the channel electron multiplier, while the multiplier gain could be varied with another supply. The input voltage to the CEM could be varied and either polarity used relative to the case and shield. This gives the effect of a retarding potential energy analyzer. The deflectors, used for energy analysis, can have any reasonable voltage applied to them relative to the case, and the entire case and shield can be set at any potential or polarity up to about 5 kv. This latter function is used to act as an extractor from the source of particles to the camera nose.

PIN HOLE CAMERA

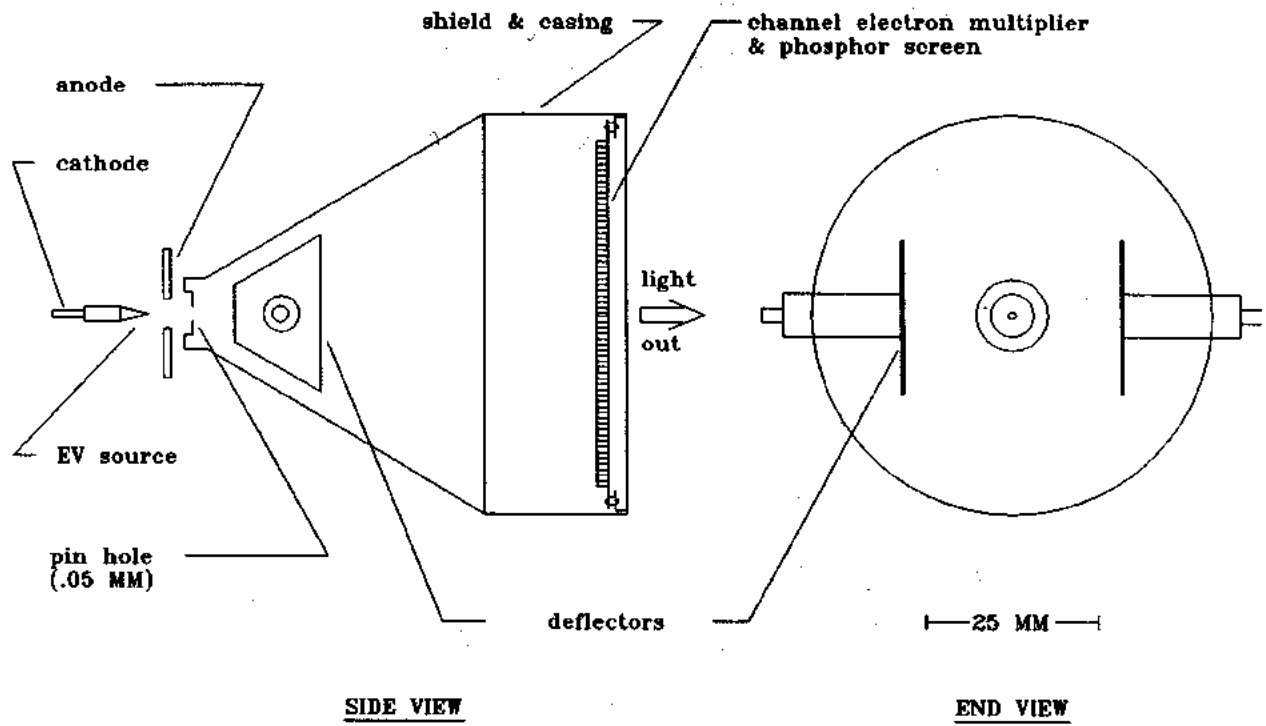

Figure 3:20

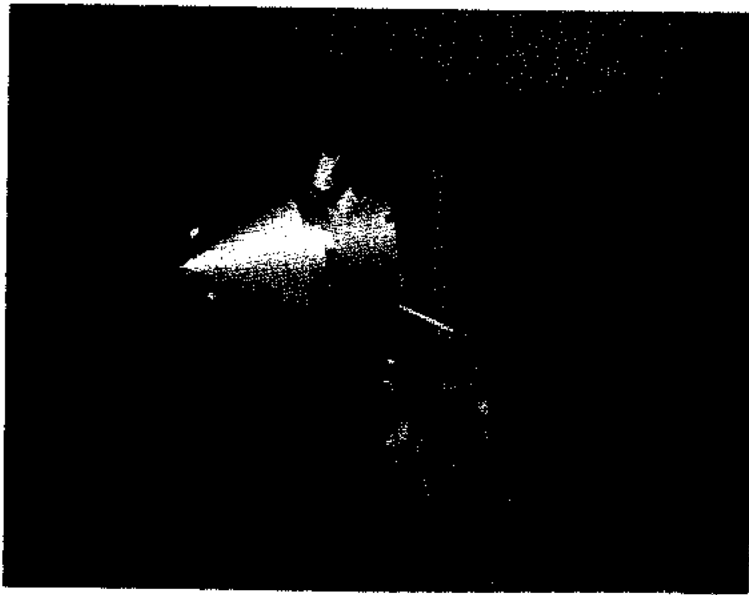

Figure 3:21

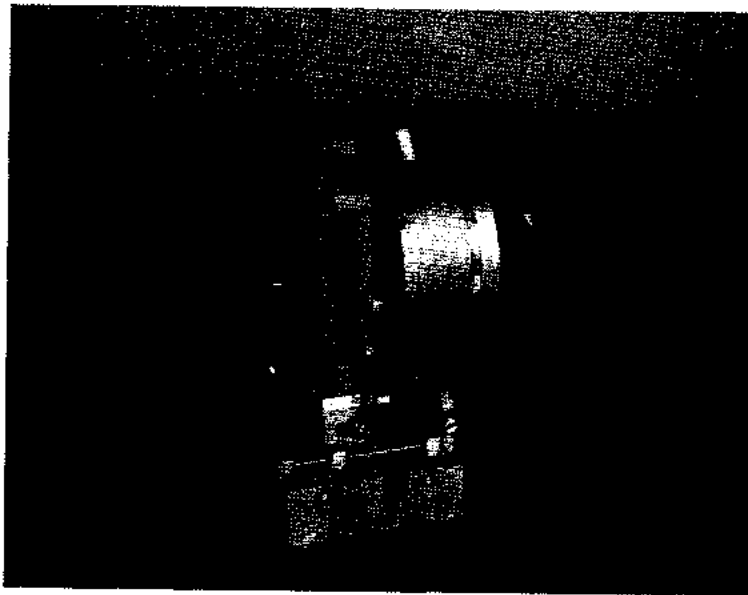

Figure 3:22

The camera had a pneumatic manipulator hooked up to it so that three-axis motion could be obtained with limits of travel of about $1/2$ inch for the Y and Z axis. A travel of 0.1 inch was provided for the X axis motion. The magnification was set by moving the Z axis of the camera with the manipulator. Normally the magnification was run at about 5, with a spacing of $1/4$ inch from the target to the nose of the pinhole camera. The field of view was determined by using the X and Y manipulators. The light output of the CEM was monitored by a TV camera, and data was recorded on a video cassette recorder. At times, the VCR also had oscilloscope waveforms mixed into it via another camera watching the scope. This system was very versatile, and a godsend when used to watch the antics of EVs at play, especially during the time when they never seemed to do anything the same way twice, but then that is getting ahead of our story.

The EV Is Caught

On September 17, 1982, the mystery of the stringy things coming out of our emission sources was over. The pinhole camera was aimed head-on at a diode source, like the one shown in Figure 3:18, and some of the many images recorded on the VCR over a period of time are shown in Figures 3:23 through 3:30. The image is a time-averaged photo taken of a single firing of the source. The streaks seen coming into the camera are enlarged at the end, due to a close approach to the pinhole camera and the resultant increase in magnification.

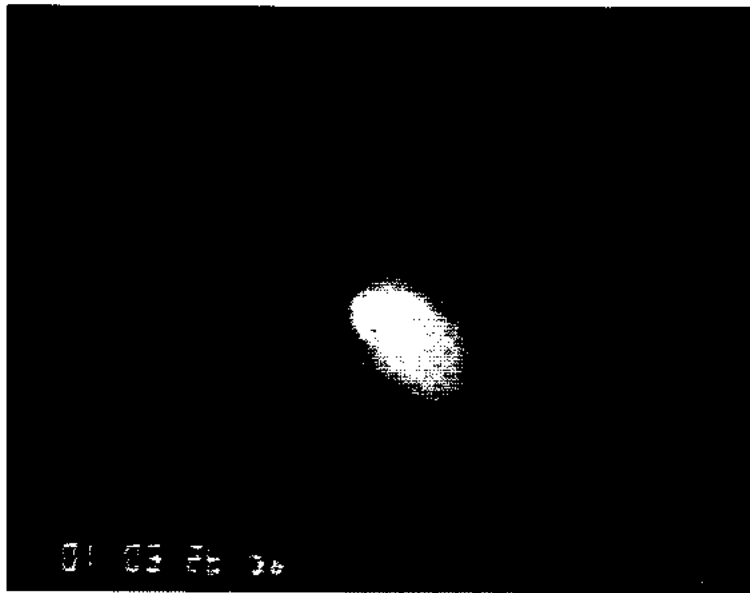

Figure 3:23



Figure 3:24

We were seeing electrons emitted by an EV that was in the process of shedding electrons and dying, much as if it was a burning ember giving off light as it died. The center region of Figure 3:23 is the source of the EV coming almost straight into the camera. Figure 3:24 shows a shot that is moving at a downward angle.

To verify that the image was indeed produced by electrons, a crude energy analysis was performed by applying a direct current voltage to the deflection plates of the camera so that charged particles were swept sideways according to their velocity, charge, and mass. An example of this kind of analysis is shown in Figure 3:25.

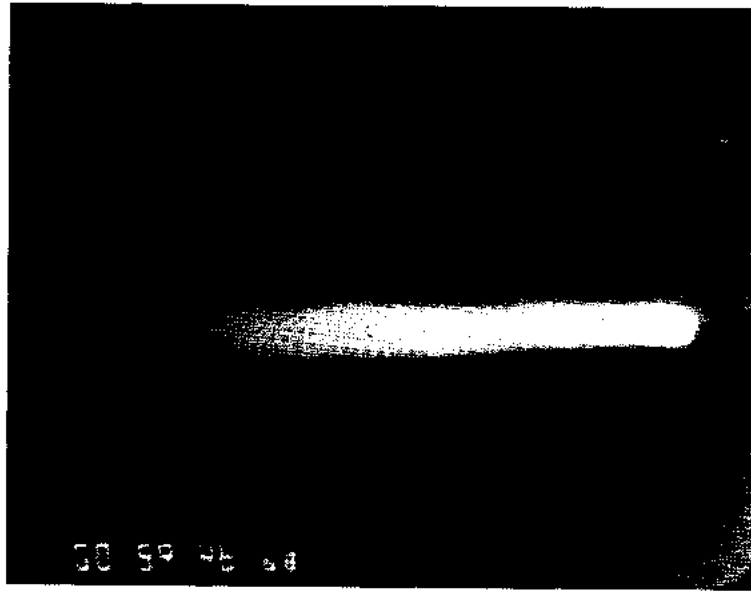

Figure 3:25

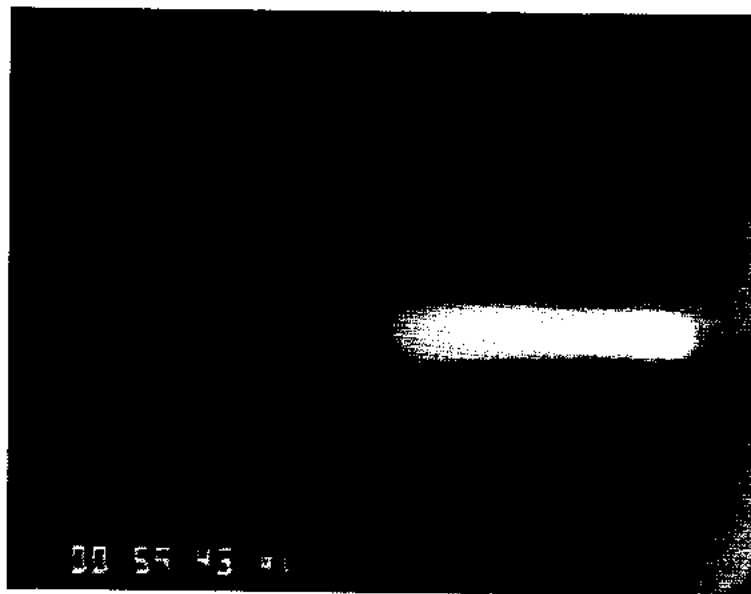

Figure 3:26

In this photo (Figure 3:25) the source has been moved to the right side of the screen to allow more room for the tail of the energy distribution to show. A very complex pattern can result from this kind of analysis, and for a true energy analysis it is necessary to know that the EV is coming straight at the camera. This can never be known for sure with this simple setup and so it has limited value. One can be relatively certain that the image in Figure 3:25 is produced by electrons having a wide energy distribution.

An improvement can be made on the energy analysis by using the retarding potential method to chop the tail of the electron distribution. In the photo of Figure 3:26 the low energy electrons have been removed by applying a retarding voltage to the input of the channel electron multiplier.

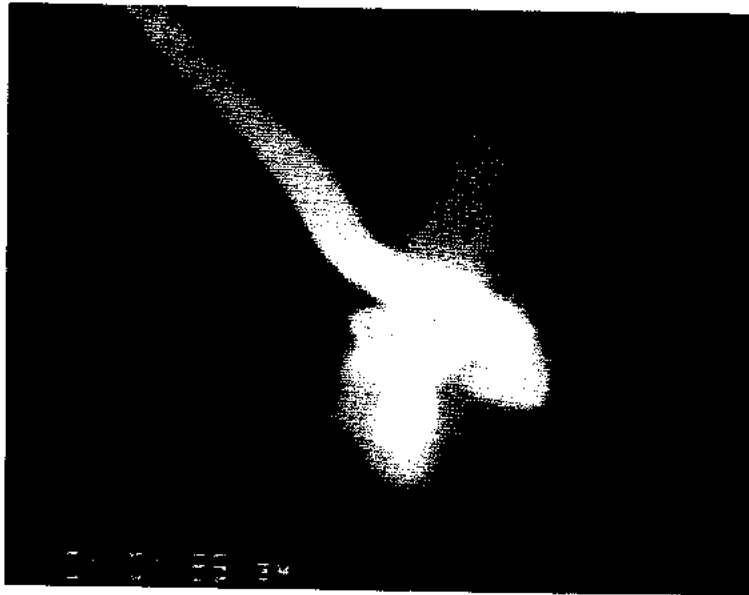

Figure 3:27

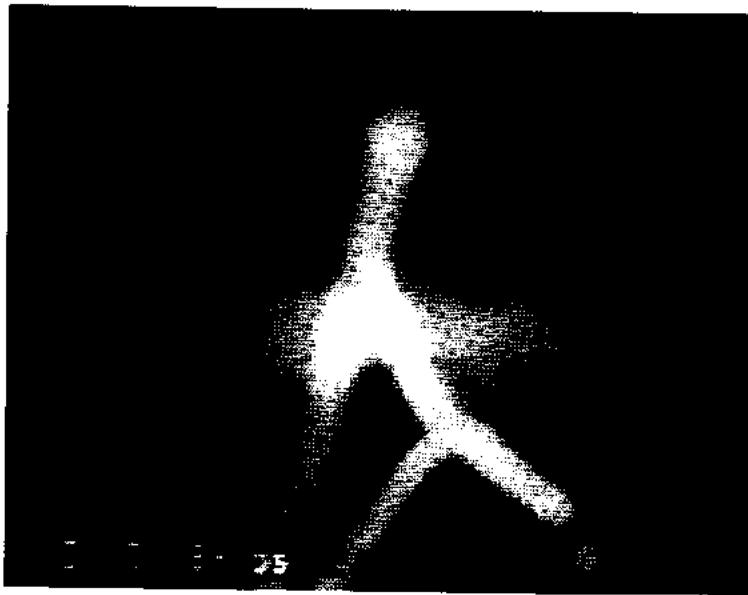

Figure 3:28

Figures 3:27 and 3:28 are examples of the absurd antics of some EVs. There is a foggy background image of a previous shot showing on these photos, and it is caused by using a pulse firing rate that is higher than the recovery time of the TV camera. Aside from the aforementioned problem, it can be seen that the EV is capable of undergoing some really frantic motions in an effort to escape coming directly at the camera.

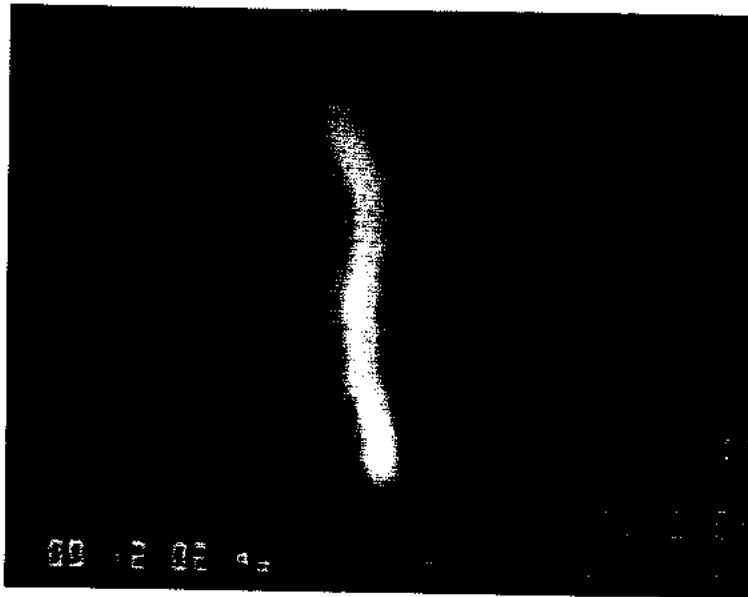

Figure 3:29

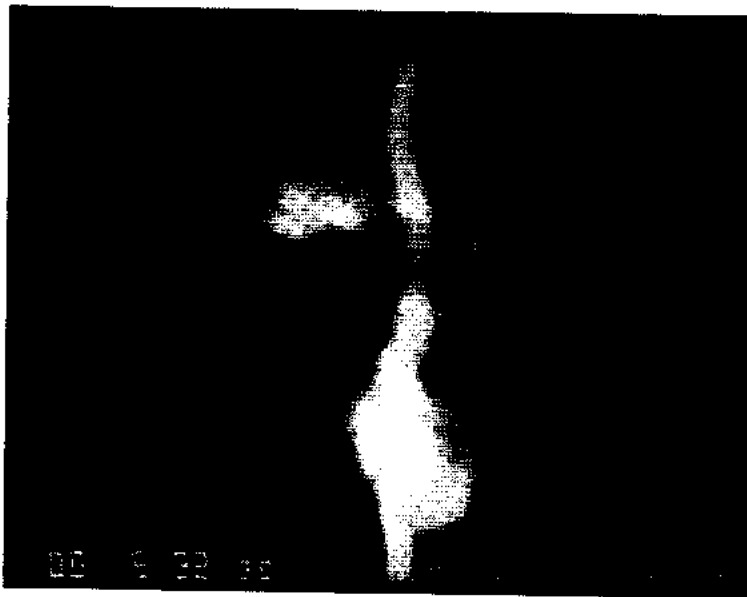

Figure 3:30

By turning the source sideways, the progress of the emitted EVs can be followed another way to verify that they actually proceed away from the source. Figures 3:29 and 3:30 are examples of this kind of observation, and a great many variations in the formation and propagation properties can be seen from shot to shot. The EV originates at the lower side of the picture and proceeds to the top. There is nothing particularly notable about the shot in Figure 3:29 except that the EV appears not to reach the target. This was probably the case in fact.

I have included the photo shown in Figure 3:30 as an example of some of the many unknowns in this business at this time. Is the EV going away from the source actually running through a nebulous ring-like EV structure, or is this just some artifact of the previous shot? The only way I can tell what is going on is to analyze the many shots, not published here, that I get on videotape.

Although EVs can finally be dealt with, and their properties ascertained in various ways, many mysteries remain. EVology is a very rich and complicated business, and there were many good days ahead in the outpouring of information that was to follow.

Chapter Four

THE OUTPOURING

Some of you may have already scanned ahead and looked at some of the later photos, and perhaps you wondered what those bizarre images are all about. Before we get to an explanation of the photos, we should first attend to some of the calibration exercises for the pinhole camera, and the associated measurements.

Camera Calibration

Among the chief concerns with the measurements involving a source and a target for EVs are these: What is the total charge in the discharge, and what is the quantity of charge transported to the target? Although there are variations on the scheme about to be discussed, it is normal to transport almost all of the free electronic charge in the source region to the anode or target region. The apparatus for doing this is somewhat unconventional in that a lot of ceramic material having high resistivity is used in the process. This normally makes charge hard to trace, but, in the equilibrium method used here, there has been no problem. The dielectric material just produces a circuit that is hard to analyze, but plasma people are used to that.

EV Source

A convenient EV source is one similar to the EV gas diode shown in Figure 3:18 except that gas is not used, and the cathode wire is made of copper wetted with mercury and pushed into the ceramic nozzle to within about $1/2$ mm of the tip. Variations on EV sources are discussed in the chapter on components and devices. The operating voltage can be lowered by firing a silver anode electrode onto the outside of the nozzle very near the tip. This electrode must be covered with a fairly thick dielectric material to keep the discharge components that come out of the tip from being collected on the anode. A fired-on coating of glass dielectric material is usually used to produce this insulation.

A region of space between the source and the collector is usually used as a filter or separator region, to assure that no disorganized components of the plasma discharge at the cathode reach the anode collector. This region can be a dielectric guide with almost unimaginable complexity, to filter out everything except the EV. Separator technique is further described in the chapter on components and devices and in the discussion on the mosaic guide shown in Figure 2:10, which represents an extreme version of filtering.

Charge Collection

For collection of the charge transported to the anode, it is only necessary to put an electrode, operating at ground potential (the same as the anode and counter-electrode of the guide), somewhere in the guide region. Accessory electrodes resembling Faraday cages can be used, but the results do not differ greatly with their use. A known load resistor is commonly used at this anode point connecting the anode to ground. Since this is the point feeding the oscilloscope, or other current measuring device, it is normal to use a 50-ohm resistor.

Care must be taken to use a sufficiently low load resistor that the voltage will not rise too high and reflect the EV. A reasonable maximum is about 500 volts for EVs made with a 2 kv pulse. Lower voltages are better. The rise rate of this voltage is very high, and an oscilloscope of adequate band width is required to measure the voltage. If this cannot be done, then a capacity load for the EV must be provided. An EV will not land on an inductive circuit or on a small wire if it has any choice. It will skip to another electrode if there is one available. For any particular wire size there is an upper EV size or current limit that can be collected. This law must be obeyed.

Pulse Power Supply

The EV is generated from a pulse voltage source with a known series resistor between the voltage source and the EV generator. By this time in the project an EG&G HY-6 hydrogen Thyratron was being used to discharge a pulse delay line into a transformer for generation of the pulse voltage. A scope is used to monitor the voltage on the EV source, and the current is calculated from the resistor value and the voltage drop. An example of the waveform often found is shown in Figures 4:36 through 4:38.

There is some difficulty in assessing the current responsible for the EV generation from these waveforms. The actual formation of the EV takes such a short period of time that it is not possible to see it accurately on a conventional oscilloscope, and all that shows is the disturbance and small step. The steps occur at successively lower voltages in the photos shown, possibly because of the plasma discharge that follows the first EV generation. Low-voltage EV sources produce the cleanest waveforms. For a 200-volt formation, the cathode voltage drops to 10 volts or so. It remains there, for a vacuum discharge, for about 3 ns, and remains, for a gas discharge, throughout the duration of the applied pulse.

The anode waveform is similar to the one obtained at the output of a scintillator--a sharp negative fall followed by a recovery determined by the time constant of the anode circuit. For coulometric work, the capacity in the anode can be made fairly large to make charge measurement more accurate.

Anode Current Values

Since most of the work reported here has been concerned with determining the detailed properties of the EV, I have not used large currents as they tend to confuse the basic processes of the EV. The current range has varied from 1 to 6 amperes. It is easy to get a value of 1 ampere from a source to an anode, with a variation from shot to shot that is sufficiently low so as to not show much fluctuation on an unexpanded scope trace. This corresponds to a variation in the 2% category, with an occasional blooper coming along that is several times this value. The pulse repetition rate for the mercury-wetted copper sources discussed earlier can conveniently go up to several kilohertz. A maximum frequency of around 10 MHz has been used for this source, but the driving pulse power supply requires a much more expensive technique than the standard Thyatron generator used on the simple pulser.

It has been found that the 1-ampere level of anode current is produced by a chain of about 3 to 5 one-micrometer-diameter beads having an overall diameter of about 3 micrometers. These are rough measurements, and are given to much variation, but these numbers will serve as a reference for future discussion. In order to make the measurements even this definitive, it is necessary to extract carefully the EVs from the plasma trash, and also to select a particular size bead-chain by employing a separation method in which one bead-chain out of a group is caused to leave the group and proceed to our measurement apparatus. This extraction and selection method is described in more detail in the following paragraphs and the chapter on components and devices.

Plasma Deflection and Cleanup

While I am on the subject of extraction from a plasma source, here are some data relative to such EV processing. Figure 4:1 is an end-on view of a plasma source without much cleanup.

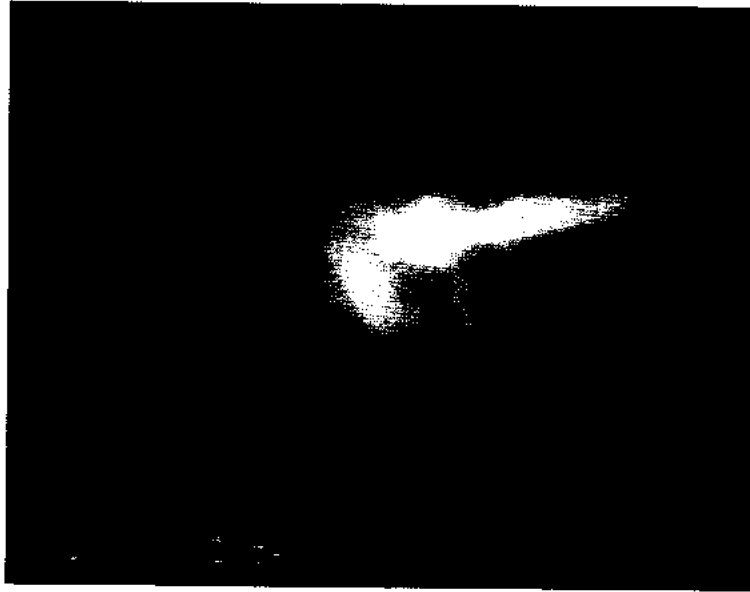

Figure 4:1

The source is a nozzle of ceramic with a 0.003-inch inside-diameter hole in it. Although it is not clearly visible in this shot, there is an electrode on the left side of the nozzle with a voltage applied to it. The voltage is positive with respect to ground, and is therefore the anode voltage that will eventually attract the EV. However, during the period of time when the EV is covered with plasma, or positive ions, the positive electrode repels the EVs residing in this positive cloud. I knew that a plasma had this net positive effect due to higher electron mobility, but I was surprised to see that the EVs contained in this sheath were deflected with it.

After a period of time and space, the plasma is cleaned off and the EV is deflected as a cloud of electrons. Figure 4:2 shows the end view of a nozzle that has been cleared of plasma. The emergent EV can be seen coming out of the center hole and striking an anode electrode nearby. This is an optical photograph taken through a microscope with a TV camera attached to it.

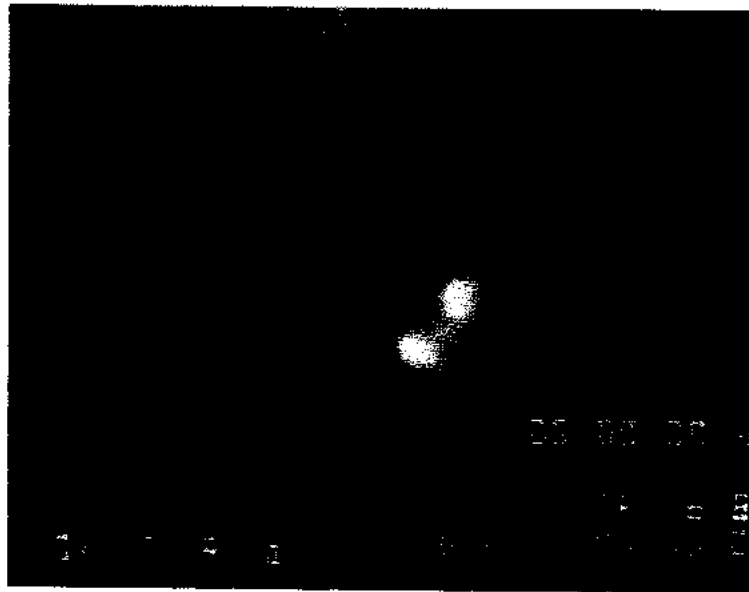

Figure 4:2

The resolution and contrast are pretty poor, but it does show the effect that is an important precursor to EV separation from a surface. If a positive voltage is applied near the exit of this ceramic nozzle, one EV out of the bunch that comes out will leave the formation region and jump a vacuum gap to the output guide circuit. This is the separator action that greatly improves the purity of the EVs used in the experiments mentioned here.

The negative voltage pulse obtained across a 50-ohm anode load, with a 50-ohm line and oscilloscope attached to it, is typically 60 volts high and lasts only as long as the fall time of the oscilloscope. The scope I use shows a 3 ns fall time. The waveform is somewhat ragged and hard to read, and stray electromagnetic leakage into the scope through the power line and other EMI sources has to be guarded against.

Charge Calculations

Under the conditions stated, assuming a delta function of charge, the calculated charge is about 2×10^{10} electrons. This condition produces a strike mark that is smaller, but similar to, the one shown in Figure 3:3, or perhaps more equivalent to the less resolved images shown in Figure 5:9 and Figure 5:13. Depending upon the conditions of flight between the cathode and the anode, a considerable number of electrons can be lost in this transit. These are the electrons that are visible to the electron pinhole camera. The number of lost electrons will be discussed in more detail later.

When collecting an EV of the type just discussed, there is a small but clearly visible flash at the anode associated with the plasma produced during the EV energy dump. The plasma radiates across a wide spectrum of energy and this further complicates the measurement of charge. It is not possible to shoot the EV into a standard Faraday cup because of the electromagnetic fields discussed earlier, but it is possible to lead the EV into a collector region by conveying it on a guide. One day measurement techniques will be standardized, but for now we just take what we get, and work with it as best we can.

Camera Magnification

Most of the photos of EVs in flight shown in this chapter are taken with a magnification of about 5 in the electron camera between the object and the phosphor screen output of the camera. There is an additional magnification provided by the optics of the TV camera and the associated display system. When all of these factors are taken into consideration, the final magnification is such that a real object of 0.1 inches in lateral extent produces an image that extends from one side of the TV screen to the other. The referencing borders of the TV screen can usually be seen in the photos of the screen.

Using this magnification of 5, the nose of the camera with the pinhole aperture in it is about $1/4$ inch from the EV source under investigation. This close proximity has not caused any interference with the experiments so far. When the magnification is varied by moving the nose in and out along the Z-axis of the camera, there are no obvious effects upon the path of the EV in the experiments discussed here.

Sensitivity Calibration

Let us now look at the problem of converting the image data obtained on the phosphor screen of the camera, and consequently the TV screen, into significant measurements of emission density from the EV in flight. The problem will be broken into two parts: (1) the calibration of the overall sensitivity of the camera, looking at a conventional, well-defined, thermionic or field-emission electron source, and (2) the application of this calibration data to EV measurements through mathematical manipulation.

For calibration, the camera is set up to look at either a thermionic or field-emission source operating at some voltage of choice, usually 2 kv for the example chosen here. The thermionic source used was a heated tungsten wire loop with a small aperture placed immediately in front of it to limit the area of emission seen by the camera. This aperture, in conjunction with the magnification of the system, determines the spot size seen on the screens. The field emitter does not need such an aperture because it is essentially a point source of electron emission. The final spot size seen is largely determined by the pinhole aperture in the camera, or the combination of the pixel size of the channel electron multiplier plate and phosphor screen.

There are several parameters that will be needed for the calibration of the camera. The 2-kv accelerating voltage is applied for only 1.5 microseconds in order to minimize considerations of phosphor and TV integration times. This voltage is applied to the cathode as a negative pulse, and the housing of the camera is held at ground potential. The gain of the electron multiplier is set by the voltage applied to it; this value for calibration is set at 2000 by the application of 760 volts. In the normal use of the multiplier for EV observation, the gain is set to 10 by the application of about 450 volts. The direct current voltage on the phosphor screen is held at 5 kv for all purposes.

The brightness level of the output image used for calibration is estimated by eye to be about 25% of the saturation level of the TV viewing screen. This is a crude method of calibration, but it has been checked with a light meter and found to be adequate for the work being done here. The area of the light spot formed on the channel multiplier is also needed for a calibration of current density into the multiplier, and this area is measured by reference to spots or scratches made mechanically on the phosphor screen of the CEM. The final measurement needed is that of current input to the CEM, and this is determined by knowing the gain and having a scope voltage-drop measurement across a known load resistance in the CEM phosphor lead wire. The camera pinhole used in the calibration work was 0.0019 inches in diameter.

Measurements can be reduced to the following values:

- 1) CEM output signal to scope for 1/4 brightness across 11.5 k ohms = 2.5 v
- 2) Area of spot on CEM screen = 0.7 mm x 2.5 mm = 0.017 cm²
- 3) Pulse length = 1.5 micro seconds
- 4) CEM gain = 2000 at 760 volts

Calculated values for 1/4 screen brightness:

- 1) Current to screen = 2.2×10^{-4} amps
- 2) Current into CEM = 1.1×10^{-7} amps
- 3) Current density into CEM = 6×10^{-6} amps/cm²
- 4) Charge collected = 1.65×10^{-13} C
- 5) Number of electrons collected = 10^6

Formula for the number of electrons/cm² to the CEM input to produce a full spot brightness of f at gain g :

$$N_e = 4f/.02 \times g_{760}/g_{xv} \times 10^6 = 2f g_{760}/g_{xv} \times 10^8/\text{cm}^2$$

The purpose of this calibration is to be able to use the camera for quantitative measurement of the emission of both electrons and ions from an EV, and to be able to determine various emission densities from this and other sources by using the measured dimensions of the EV from witness plate shots, or by assuming maximum size dimensions from the camera images. In a fashion similar to the one just described, the sensitivity of the camera to ions has been measured by using ion sources of lithium.

EV Emission Calculations

For an object distance of $1/4$ inch, and an image distance of $1 1/4$ inch in the camera, a point object or source will image as a disc about 3×10^{-2} cm in diameter. The EV image in motion is seen to exhibit an intensity f of 0.5 on the TV screen at a gain of 10, and have a minimum width of about 3×10^{-2} cm. The corresponding area on the phosphor screen is 7×10^{-4} cm². The number of electrons arriving on an area corresponding to an image of a stationary EV is this:

$$N_e = 1.4 \times 10^7 \text{ electrons.}$$

The corresponding number of electrons given off in all directions, assuming isotropic emission, is this:

$$N_e \times 12.5 (1/4")^2 \div 3.1(0.001")^2 = 3.5 \times 10^{12} \text{ electrons.}$$

The ratio of track length to EV diameter in the camera view is 1000 micrometers/10 micrometers or 100, hence the total number of electrons given off during the flight past the camera is 3.5×10^{14} electrons. The corresponding number of coulombs is 5.6×10^{-5} .

If the surface of the EV is taken to be about 3×10^{-6} cm² from a measured diameter of 10 micrometers, then the current density at the EV surface would be 6×10^{11} amps/cm². For a pure electron EV model having a translational velocity of $c/10$ or 3×10^7 m/s, the rate of emission would be approximately 10^{25} electrons/s or 1.7×10^6 amps. The calculated lifetime of the EV would be $10^{-3} \div 3 \times 10^7 = 3 \times 10^{-11}$ s. This lifetime is in accord with observations on heavily loaded or disturbed EVs. These calculations also show the charge density of the EV to be about 6.6×10^{23} electrons/cm³, approximately that of a solid.

Not all of these numbers will hang together, and it is not my intention to convince anyone of anything with such number games. This exercise is just an attempt to show the incredible difference between the ordinary world of electronics and the EV world. It should be recognized that a pinhole camera is not a very efficient device, yet it will image an EV onto a phosphor screen without any gain applied, and this stunt requires a lot of emission density. On the other hand the EV is capable of passing by the camera so quietly that a gain of over a million will not detect any emission. There has to be some use for this kind of thing.

The measurement methods and calibrations used here are not highly accurate, but they do serve as a good guide for workers in the field. We have not been grossly misled by using the methods presented here.

EV Action

It is difficult to choose (from the many available video photographs of EVs in action) just a few to illustrate some of the things EVs do. I do not have an adequate explanation for many of the things they do, so I will not show such occurrences. Even the photos I will show do not have adequate explanations, but at least the effects repeat themselves enough to be worthy of some comment.

Blinkers

To begin the description of EV antics, let's look at Figures 4:3 through 4:5. This is an end view of a gas diode source and the photos shown here are a part of the series shown in the last chapter. In Figure 4:3 there is a question of whether we are looking at one EV with a gap, or two EVs with the source of one of them somehow cut off from our view.



Figure 4:3

By referring to Figure 4:4 and Figure 4:5, it is possible to see how there was actually continuity between the two parts of the same entity.

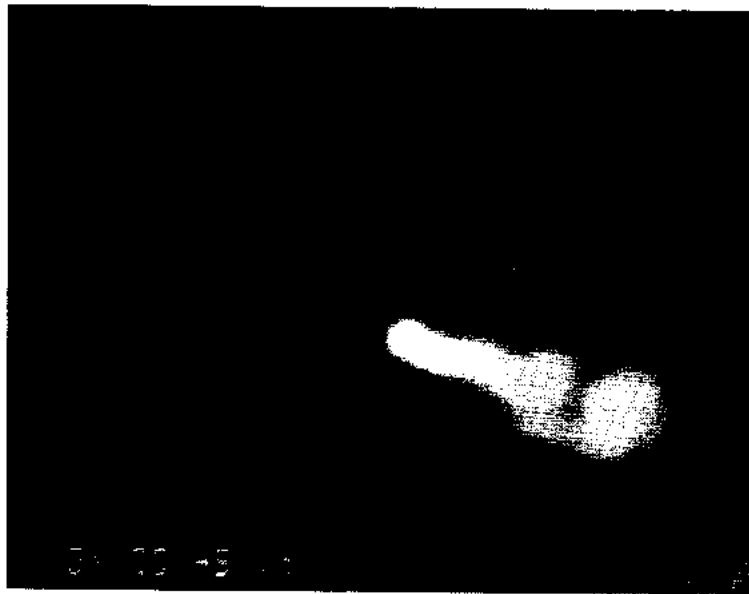

Figure 4:4



Figure 4:5

My interpretation of these photos is that the EV blinked out for a moment, because of some unknown cause, and then returned for a brief moment before disappearing from the screen or dying altogether. I would not attempt to claim that in these photos the EV went somewhere else and lived on; it probably died, but one must be constantly aware that disappearing from the screen does not mean the EV has died. There will be many examples later of disappearing acts that are followed by dramatic reappearances.

The model I keep in mind is that an EV is traveling in a potential well that comprises its electromagnetic container. It is possible to stimulate this container and lose electrons by either thermal-like processes or tunneling processes. Both of these excitation methods come from static field configurations of surrounding structures which the intense moving field of the EV is likely to excite. In short, the coupling coefficient between the EV and its physically rough surroundings is very high; this is prone to produce high-frequency excitation of the EV potential well, resulting in loss of electrons. You cannot easily drive a full bucket of water over a rough road without losing some water.

Energy Analysis

I included Figure 4:6 to show some of the most horrible examples of energy analysis by the deflection method. There are multiple exposures on this frame and the initial paths of the various EVs were not straight enough for decent analysis. One thing worth noting is the detailed structure showing in the tail on the lowest EV trace. This kind of structure is occasionally seen at high energy level (around 2 kv) and seems to be trying to tell me something. When a good spectrum of this 2-kv blip in the energy distribution is seen, there is usually a disturbance that follows in the form of a deflection. I tend to think of the EV potential-well depth as being around 2 kv. This is very high for chemical entities, but then, we are not dealing with chemistry. The X-ray emission spectrum that is emitted when an EV dies suddenly also seems to be peaked at around 2 kv. This is a subject that will be discussed later.

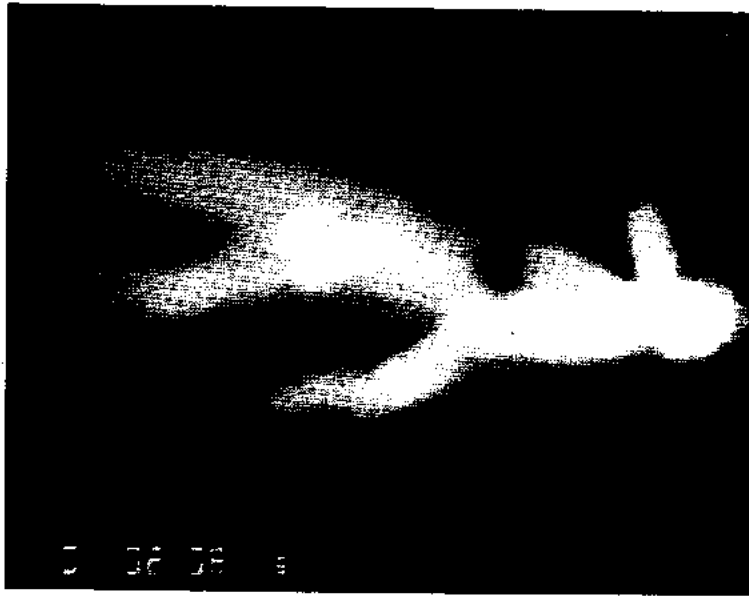

Figure 4:6

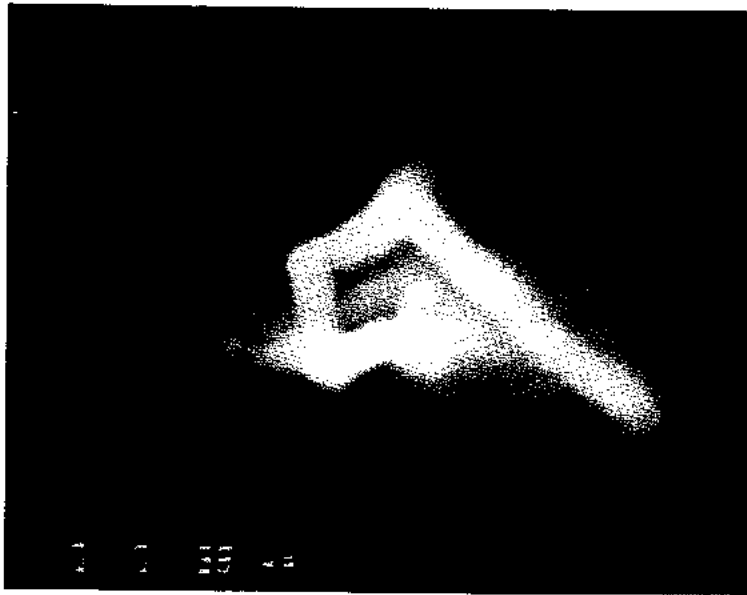

Figure 4:7

Kinky EVs

Figure 4:7 through 4:9 show some really kinky behavior. These shots, like the previous ones, are coming straight out of the source into the camera. The most noteworthy thing about these photos is the way the EV goes straight and then abruptly turns, with perhaps a little extra emission at the corners. In all of these shots the EV originates in the center and seems to have reasonably equal leg length between turns. This is true not only on the shots shown, but on many others available.

I have a notion of what causes this effect, but there is certainly no proof at this time. I have suggested before that some EVs are very tangled at birth, or become so by rolling across a surface, and that a flight across a vacuum or a low-pressure region allows them to straighten out into a circular configuration. This untangles the amulets, often found to be regularly spaced, as the EVs go along through this region.

I imagine that this process of unwrapping is a disturbing one, and shakes the potential well sufficiently to cause electron emission, perhaps in a specific direction, and that this jetting action is responsible for the abrupt turn. In another scenario, I can see how the disturbance could cause an imbalance in container geometry causing a propulsion effect from radiation asymmetry. I can also see how such disturbances can be quite periodic, by virtue of the symmetry in the EV structure, and how this bears on the question of why the periodic turns occur. Of course all of this is highly conjectural, but it is nice to have something to hold onto while going through the dark woods.

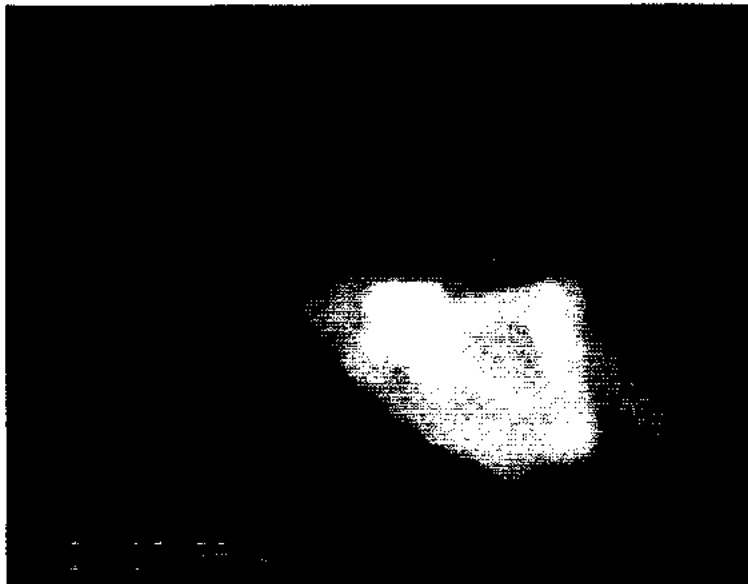

Figure 4:8



Figure 4:9

Figure 4:10 is a side view of an EV from a gas diode source that has originated at the lower part of the picture. One reason for showing this picture is to reinforce the thought that something is turning abruptly in a more-or-less-rectangular pattern with some very definite bursts of electron emission at the corners of the rectangle. In addition, there is the possibility that another EV is shooting past the rectangle heading toward the top of the photo. The lower overall density of this shot allows better analysis of the electron bursts. In many of the other shots, the TV system is well into its saturation region, and the electron bursts do not show well.



Figure 4:10

Consorting

In the next series of photos (Figures 4:11 to 4:14), I would like to suggest there is some consorting between two EVs coming out of the gas diode source (as seen in the side view). Again, the flight path originates at the lower side of the photo and proceeds to the top. Several things can be seen in the photos.

There is a general tendency for the EVs to become less associated as they proceed away from the highest pressure region of the source, although there is a faint suggestion of expansion and contraction in a periodic fashion between them. This action is reminiscent of the fission-fusion behavior seen while EVs travel on a dielectric surface. It cannot be said for sure whether or not the EVs are traveling together or sequentially, but at least something has synchronized their paths to an interesting degree and produced what appears to be a 180-degree out-of-phase relationship.



Figure 4:11

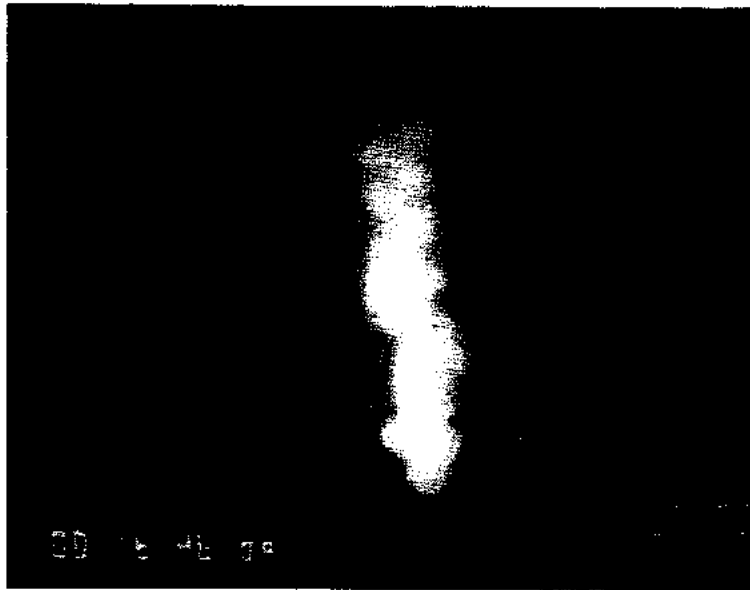

Figure 4:12

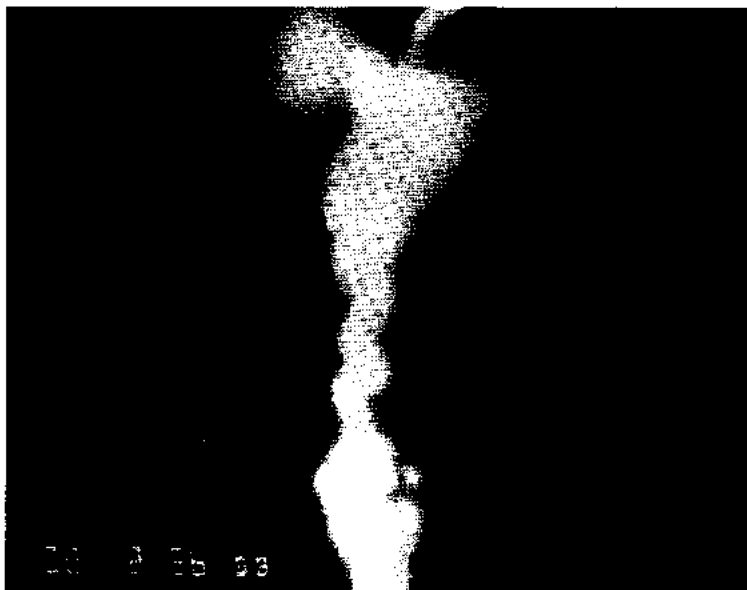

Figure 4:13

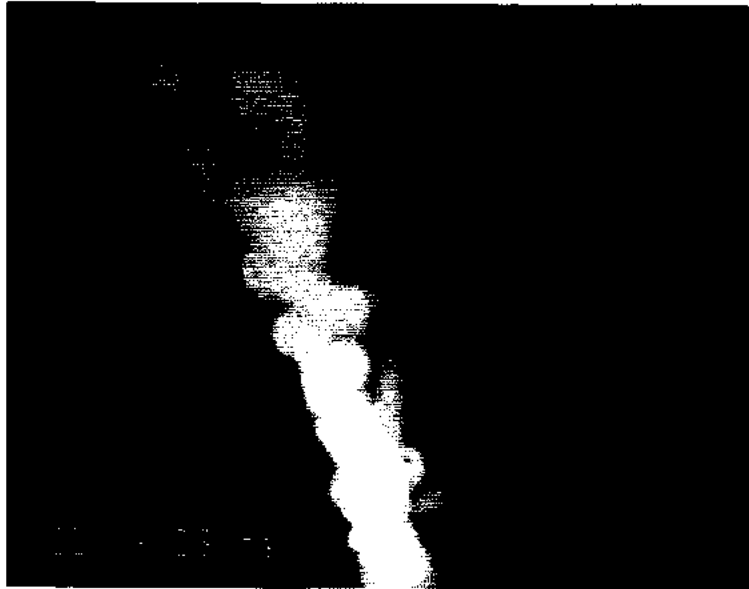

Figure 4:14

Deflection Tests

The next series of photos (Figures 4:15 through 4:29) will attempt to show several important features that were not clearly available up to this time in the measurements. One feature will be a crude measurement of the velocity of an EV in vacuum flight. There will also be clear evidence shown for the individual nature of the high charge density entity, the EV. There is also supporting evidence for the ability of an EV to switch rapidly the potential on electrodes. In the same series it will be shown that a single burst from a particular EV generator, or source, can produce several reasonably well-spaced EVs. Finally, in this series the blinking or modulation ability of electron emission from an EV will be shown in very graphic form.

The setup for one of these experiments is to use a mercury-wetted copper EV-source operating in a "dog house" so as to suppress stray plasma emission. The EV thus formed is led out of the formation enclosure across a resistively-coated dielectric surface, or guide. The guide is terminated as a pointed ceramic structure aiming at two electrodes located in vacuum and spaced about 1 mm from the launching guide. The arrangement of the electrodes is shown in Figure 4:15.

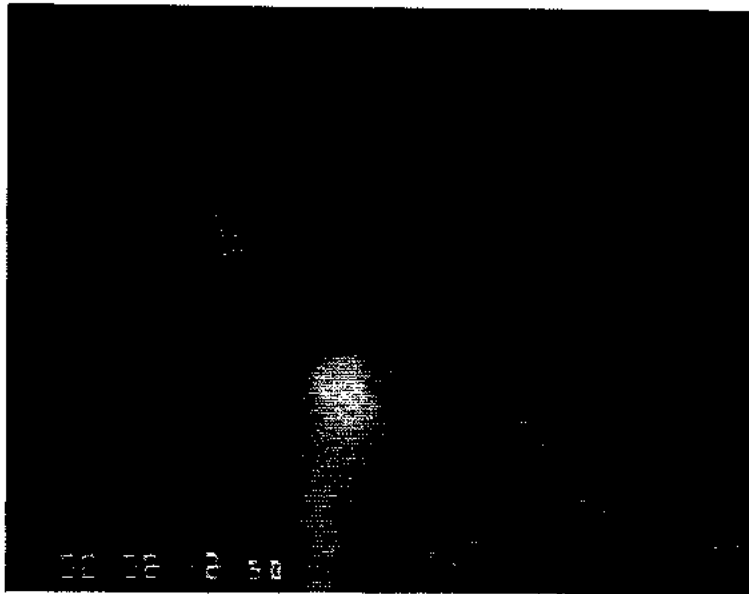

Figure 4:15

The closest electrode to the EV source is shown in the lower center part of the photo as a lighted area caused by a striking EV. There is another electrode about 1 mm beyond the first one and located to the left in the photo. This electrode is also shown slightly lighted, possibly by an EV striking it. To get these photos the camera is essentially watching the EV move sideways toward two small wires extending downward from the plane of the photo. The wire diameter is about $1/64$ inch and the length is adjusted to make a $1/4$ wave resonator working against a ground plane at whatever frequency is desired.

Picoscope

This experimental setup is a very complicated one but well worth the effort because it performs the function of a picosecond pulse generator and an oscilloscope with a real-time effective horizontal sweep in the picosecond range. With this configuration, waveform measurements can be made in real time to 10^{-13} seconds. This is not an accurate device, but it sure opens some frontiers. The basic technique is to treat the EV as if it were some kind of electronic burning ember that can be deflected by electric fields and imaged on a recording device--the pinhole camera.

One of the most basic considerations is the speed of the ember, or EV, running across the view of the camera. We have used voltages for EV manipulation that give a velocity of around $c/10$. This has been calibrated by a variety of methods (none of which are very accurate), stemming from knowing a particular frequency that is applied to the deflectors, and using this voltage as a deflection signal. Unfortunately the frequencies needed for calibration are too high for easy generation in my laboratory by standard methods, so I have to resort to left-handed methods to do what I want. These methods consist of using harmonics of a magnetron to excite various tuned structures that are under analysis by a spectrum analyzer up to a top frequency of 18 GHz, the top frequency of my analyzer. Beyond that frequency it is necessary to fly blind by working with tuned stubs that are supposed to be something like loaded $1/4$ wave antennas. When all of this is done, it is found that an EV will excite such structures and show a wiggle that is due to mutual coupling.

Knowing the frequency of the stub and the dimensions of the wiggle, it is possible to estimate the EV velocity. Amazingly enough the velocity is near to the $c/10$ that was predicted for the operating conditions chosen. It didn't have to come out this way. For the dimensions shown on the photos the EV takes about 3×10^{-11} seconds to go between the bottom of the screen and the first electrode. A similar time delay exists between the two electrodes because they have a spacing of about 1 mm. The best time resolution that could be obtained from the relatively fuzzy photos shown would be about 3×10^{-12} seconds.

Picopulser

In addition to being able to see what is happening to the EV, it is also necessary to have a method of producing the time-varying voltage on the electrode that is to wiggle the EV. In the experiment under discussion, this is done by using the first EV (of a train of several EVs) to excite the deflector electrode, while another electrode is used to collect the second EV passing by the excited electrode. Of course to get this timing to work out takes a lot of compromises in the experiment, such as using big fuzzy EVs in order to get the desired sequence of events to take place. Let us now name the centermost and closest electrode the *deflector*, and the uppermost and left electrode the *collector* (both shown in Figure 4:15). With these names in mind we can set up the sequence of events that will take place.

Sequence of Events

When an EV train is fired off, the first one strikes the deflector electrode, producing a damped wave train of oscillations at the natural frequency of the deflector. That the deflector was struck can be verified by the trace going to it, and by the intensity of the emitted electrons from the electrodes. It actually looks as if it had been hit by something. As a test of the validity of the assumptions here, it is possible to apply a direct current bias voltage to either electrode and control which electrode gets hit, or whether either gets hit. The control is quite effective. When the two voltages on the electrodes are properly proportioned to receive the first EV on the deflector electrode, and the second on the collector electrode, an amazing thing can be seen. The EV to the collector is actually deflected in some periodic fashion. Even though this was the aim of the effort it is still amazing to me that it actually happens.

In the photos from Figure 4:16 to Figure 4:21, it is clear that the EV path on the left side of the photos is trying to follow some fairly damped high-frequency voltage variation. There are vagaries and variations in the waveforms, but these could be due to many things, not the least of which is the extra EV that gets thrown in every now and then and can be seen striking the deflector electrode. For very wide deflections to the left, the EV image is cut off by the deflector plate in the camera and that accounts for the broken path in Figure 4:17.

They Are Short

One thing should be very clear from the photos: the EV is essentially as long as it is wide, just as the deflected images on the high-resolution witness plates suggest. There is no smearing on the photos such as one would get were a long shape deflected. It should also be fairly clear that the timing between the EVs is fairly regular and the spacing is something like the characteristic time of the system: 10^{-12} seconds. I am not sure what parameter in the source produces the spacing, but from other observations it seems to be controlled by the size of the bead-chain that is used. The bead-chains seem to be spaced about one chain diameter apart. There is nothing rigorous about these notions but all of this helps to fill in the picture of how some of the helical structures shown in Figure 4:14 are put together.



Figure 4:16



Figure 4:17



Figure 4:18



Figure 4:19



Figure 4:20

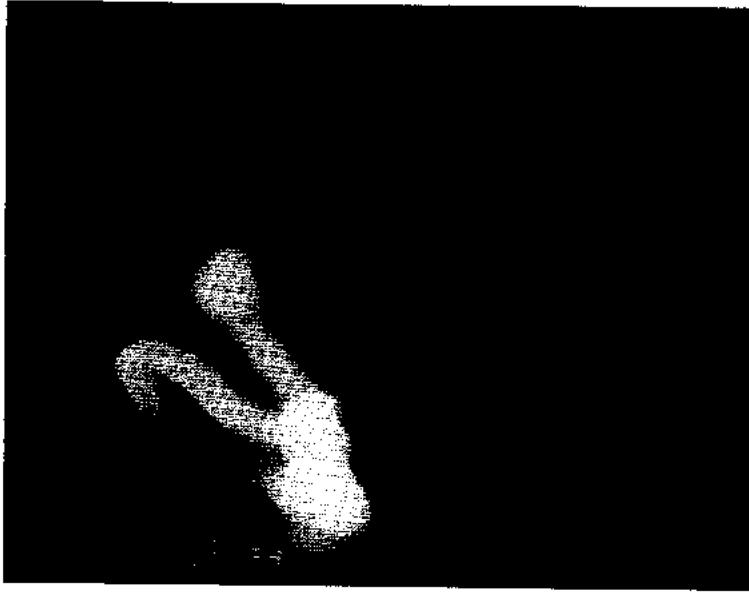

Figure 4:21

Emission Modulation

There is another indication in the group of photos just presented that will also be shown much more clearly later--the non uniform brightness of the deflected EV. The EV shows a fairly faint trail when it is turning in a large radius as it enters the view at the bottom of the pictures. As the EV is more sharply deflected, it generates a brighter image indicating more electron emission has occurred. This lends credence to the notion of a potential well that can be sloshed enough to emit electrons. Of course, another possible explanation for this brightness change is that the EV has undergone a velocity change. I can't tell which notion is true but I prefer the one involving the modulation of a potential well.

To help clarify some of the questions having to do with emission control from an EV, and also to get a better view of their spacing habits, a modification to the above apparatus was made. This modification consisted of using only one electrode to act as an EV collector. The location of this electrode is shown in Figure 4:22 as a bright spot at the top of the photo.

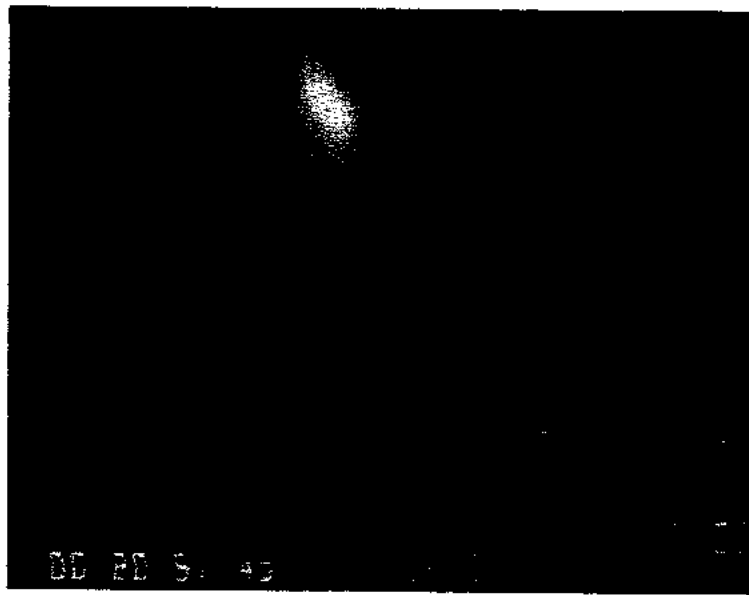

Figure 4:22



Figure 4:23



Figure 4:24

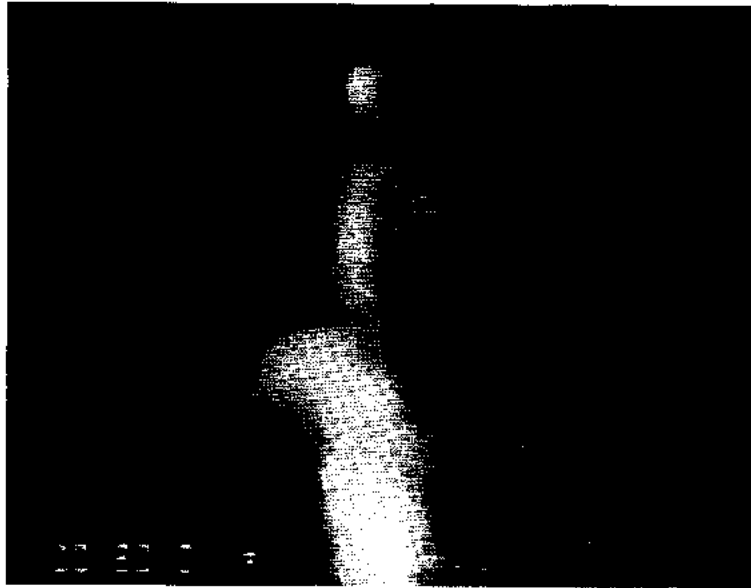

Figure 4:25



Figure 4:26

The trail of an EV to this target is fairly faint because there is very little disturbance in the system and, for this shot, probably only one EV in view. Figures 4:23 thru 4:29 show different degrees of activity caused by the random variations between shots. My interpretation of these photos is that one EV got through to the collector and excited the electrode which was then able to undergo a damped oscillation. The field from this initial impact excited the remaining EVs on their way to the electrode.

At one point in this experiment, when most of these photos were made, the voltage on the electrode was just marginally able to collect the first EV. After the initial collection there was a long recharge time relative to the spacing of the oncoming EVs, and they could not land on the electrode that excited them. These EVs were deflected to the right of the electrode and off somewhere else. The combination of the direct current and the submillimeter wave field produced the path of the EVs approaching the electrode.

One very interesting feature of these photos is the relatively high modulation index of the EV. The emission is cut off to a value of at least $1/100$ of the *on* state as shown in the photos and if the gain of the multiplier is turned up to explore the limit, it is at least $1/1000$ of the *on* state. This effect has to be explored with a microscope looking directly at the CEM phosphor, instead of using the TV camera, due to the overloading effects in the TV camera.

Another point worth considering is that a steady emission of electrons from this little portable battery is both started and stopped in a fairly symmetrical fashion, in terms of exciting field amplitude, and that the time scale for doing this is clearly in the sub-picosecond range. Some switch.



Figure 4:27



Figure 4:28



Figure 4:29

In this series of photos not all of the effects seen can be explained. At this point in the project the best way to get answers is to somehow surround questions with a lot of little answers. Then it seems that their combined value is greater than any *one* question answered as perfectly as we can frame the question.

Inductance Effects

Up to this point all of the photos of EVs have been shown to be clear of the effects of catching an EV in the target area of the camera. If the EV is allowed to be caught on a low inductance target within view of the camera, there is usually a loss of image quality because of stray radiation from the impact point. I stress that the inductance of the target must be low, but *low* is a very qualitative term that should be expanded upon before we go on much further.

As I have mentioned before, an EV will not easily land on a small wire. If the image of the landing is viewed in the camera, the EV can be seen skipping over the wire surface before finally hitting it. I believe this is simply caused by the EV

depressing the voltage on the wire so greatly with its own negative charge that the wire is unattractive to the EV. A larger wire or a large area surface (the usual signatures of a low inductance or low impedance) is able to supply the instantaneous charge demanded by the EV and prevent the depressed potential effect. It is always important to consider the impedance and wave velocity of the circuit being considered for an EV landing site.

X-Rays?

I will offer two explanations for the observations that follow. One of these explanations seems preposterous while the other is absurd. Although the effects to be explained are very graphic, I am not too disturbed by not knowing their cause exactly. I will tag the first explanation the "X-ray process" and the second I will call the "enhanced electron-mobility effect."

When an EV is caught on a low inductance circuit, it appears to release its energy rapidly enough to produce a large quantity of X-ray photons having energy in the 2 kv range. One demonstration of this effect is shown in Figures 4:30 and 4:31. In both of these photos the camera was watching an EV come at the nose of the camera from a source viewed end-on. The main difference between these photos and the earlier ones is that the EV was allowed to hit the camera nose instead of the anode aperture external to the camera. What is showing in the photos is a white flash of emission in the center of the screen, probably due to the EV approach, and some images that are not usually seen.

The thin vertical objects to the left and right of the center flash are shadow images of the deflection plates in the camera. The insulators holding the plates extend left and right at the center of the photos. In addition, there is a dark spot just above center left in both photos near the deflection plates. There is also an artifact of photographing the TV image that should be ignored. This is the diagonal band running from top left to lower right and it is a synch bar image resulting from photographing at too high a shutter speed.

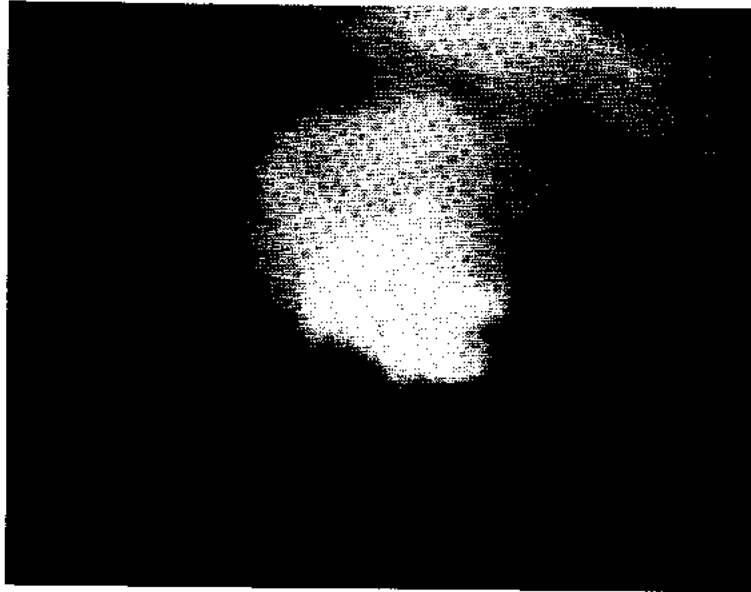

Figure 4:30

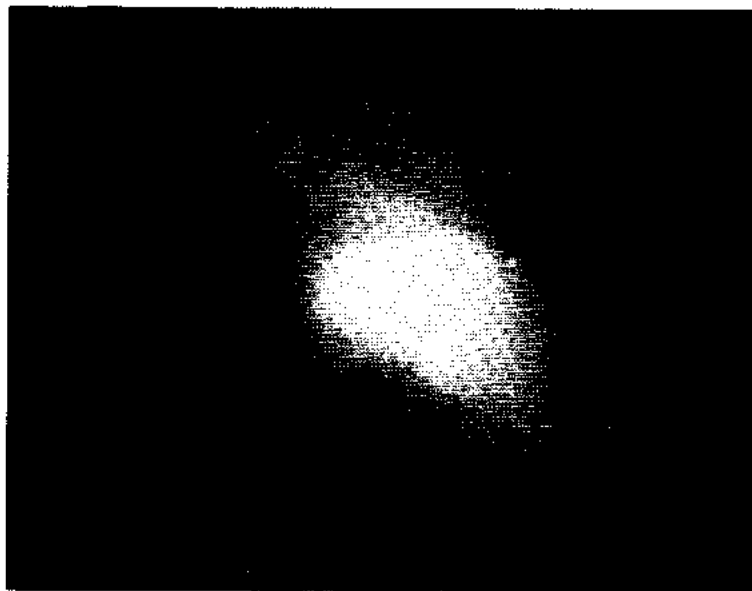

Figure 4:31

It has been found that the image of the deflection plates is caused by a point source of electrons having an energy of around 100 volts. In this first interpretation it is presumed that these electrons come from the inside of the camera housing and are produced by a small area X-ray source outside of the housing where the EV struck. Additional data to corroborate this assumption is provided by the dark spot that is always present when this effect occurs. The dark spot could be caused by a shadow from a brass insert that holds the camera aperture in place. There have been many measurements taken whereby the nose of the camera is polished before a EV strike occurs, and then is examined after the strike to determine the position of the strike and correlate it with the brass insert producing the dark spot. Correlation is always found.

This point-projection image effect is always produced when an EV strikes the low-inductance nose of the camera. It is never found when an EV is let down easily on a high-inductance target.

When calculations are done to determine the X-ray intensity that must be present to produce all of the electron emission recorded, the numbers reach such staggering proportions that the mechanisms used for calculation become suspect. For example, it is estimated that the screen intercepts about 0.01 of the electrons produced on the inside surface of the camera by the X-ray strike on the outside, if the electrons are produced isotropically. It is further estimated that 0.1 of the X-rays reach the production sites due to the geometry of the EV and strike site. Only 10^{-4} of these will produce one electron near enough to the surface that can escape to the imaging screen. From screen brightness considerations it is estimated that 10^9 electrons struck the channel plate multiplier.

Therefore $10^9 \times 10^2 \times 10^4 \times 10^1 = 10^{16}$ X-rays are required to light up the screen as it is observed. If 10^7 X-rays are required to produce a single recordable electron, 10^{23} electrons from the EV are required to produce the observed lighting of the phosphor. If the electron-emitting disc of the EV has an area of 3×10^{-6} cm², the electron flux density is 3×10^{28} electrons/cm². Even with these large numbers the current density of photo electrons in the camera would only be 5×10^6 A/cm² and would not cause space charge degradation effects of the image beyond that seen.

The mechanisms for X-ray and photo electron production are just too difficult to assess at this point; I cannot get too serious about calculating EV properties from the observed X-ray effects. There are just too many missing pieces of data. The X-ray emission could even arise from a form of synchrotron radiation from magnetic field collapse, or from bremsstrahlung.

Enhanced Electron Mobility?

The second explanation for the image production (Figures 4:30 and 4:31) stems from the notion that there is something amiss with standard calculations for electron-penetration distances in a metal, or at least amiss with using the standard penetration distances whenever an EV is involved. One interpretation could simply be that the range of electrons in metal is greatly increased by the internal fields produced in the metal by the interception of an EV. What we are seeing in these examples is electrons emerging from the second side of the target, or even exoelectrons launched from the metallic surface by mechanical shock. In any event, an extreme upset to normal equilibrium is recorded.

I would now like to introduce an experiment, very similar to the one just discussed, to help stress the difficulty of having an adequate electron supply at the target site for an EV. In the pinhole camera drawing in Figure 3:20, let us put a 0.00025-inch thick foil of aluminum across the 0.040-inch hole in the anode. Using the same EV source in the previous discussion on X-ray effects, let us launch an EV at this target so as to strike the foil in the center while watching the result with the camera.

I can tell you the result was not too good because the foil had a hole blown through it, and the camera was highly insulted. If we increase the foil thickness to 0.001 inch, the EV does not blow a hole through the foil, but it does dent the foil nicely with a perceptible bulge on the reverse side. Actually, the anode is a little different from the drawing in that it is an integral part of the nose of the camera to help prevent stray radiation fields.

Speckles

When the camera is first turned on, and an EV is allowed to strike the foil, an image is produced as shown in Figures 4:32 through 4:34. The main difference between these photos is the amount of anode voltage applied for extracting the EV. There is a critical threshold for extracting the EV from the source; once this voltage level requirement has been met there is little need for more. However, for a small voltage increment past this critical level, different things can be seen. The voltage difference from Figure 4:32 to Figure 4:35 is only about 50 volts out of 2000. More about the action of this EV selector technique is described in the chapter on components and devices.

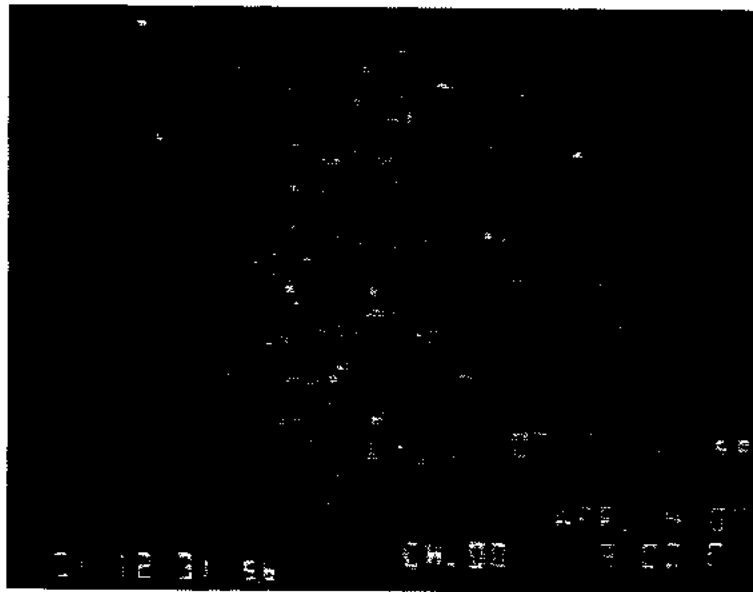

Figure 4:32

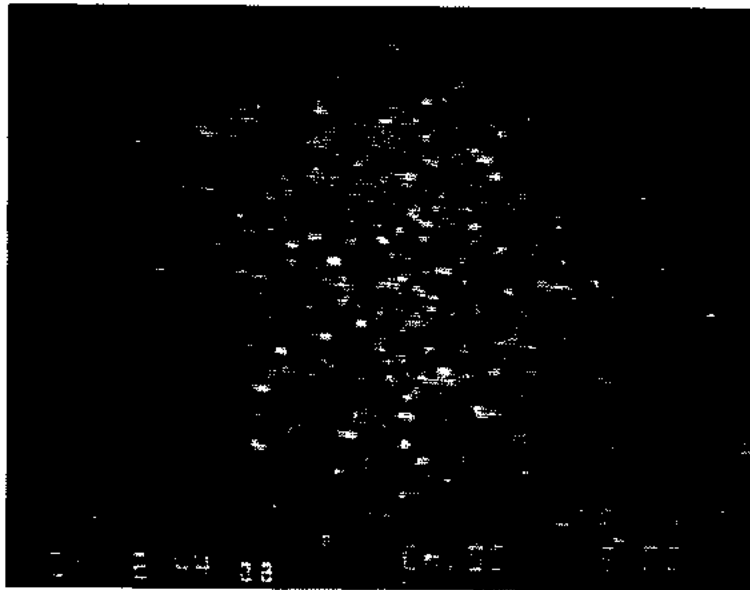

Figure 4:33

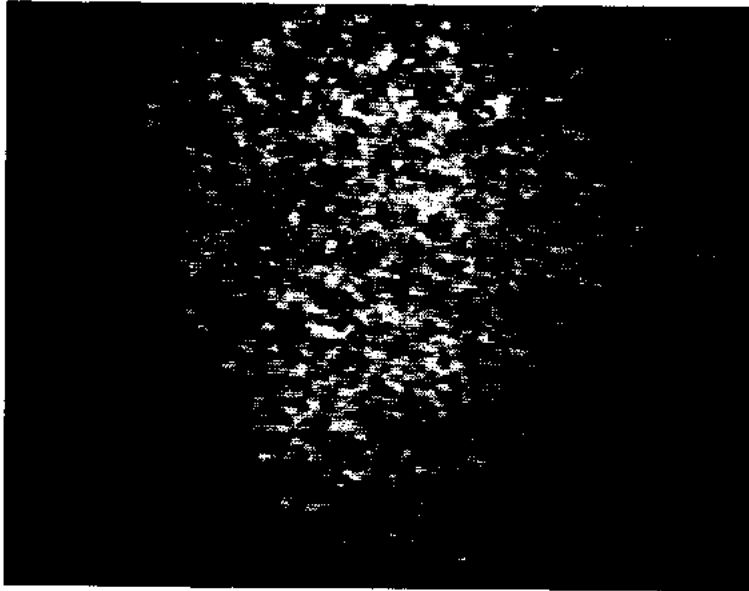

Figure 4:34

When I first saw this speckled pattern I thought I was onto some diffraction effect produced by the EV, and at the root of all knowledge. It was a great disappointment to find the effect was caused by little 100-angstrom specks of aluminum oxide that detached themselves from the aluminum foil as a result of the shock treatment the EV was giving the foil. I actually had to collect samples of these flakes and analyze them in a transmission microscope before I would believe this was the cause. Giving up my diffraction patterns was pretty hard. What put me on the correct path was the observation that the aluminum foil would clean up after bombarding the foil for an hour or so. After the foil was clean, the pattern was that shown in Figure 4:35. I still have trouble believing that aluminum oxide particles can give rise to electron emission in a CEM, but the evidence is overwhelming.

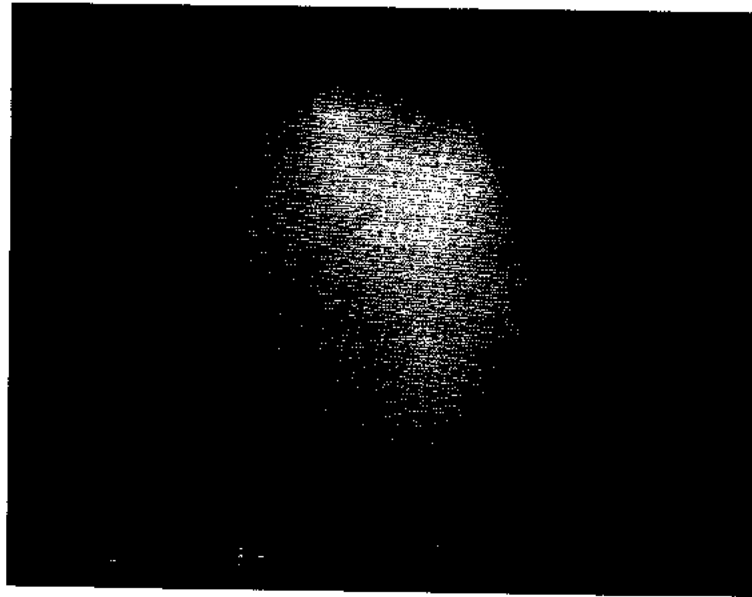

Figure 4:35

Thermionic-Like Pulse Emission

The mystery was not over yet, however, because I could not explain the pattern in Figure 4:35. I originally put the aluminum foil ahead of the camera to get a cute form of EV-scope in which I could image the landing of EVs with high resolution. This just flat did *not* work. What I got was an image with a lateral dimension of over $1/32$ of an inch, and this was totally useless. This effect turned out to be useless for imaging, but it is a real whiz-bang of a pulse generator.

By performing an energy analysis on the electrons forming Figure 4:35, I determined they had a spread somewhat similar to thermionic emission arising from a negative potential of 2 kv. How could this be? Electrons are not supposed to have range enough to penetrate the 0.001-inch foil target. It finally dawned on me that possibly the foil was actually being pulled down to this negative value by the arrival of the EV, and that the momentary heating of the aluminum did indeed produce thermionic emission. How wild!

Calculations were made on all kinds of things such as the inductance, resistance at elevated temperature, specific heat arguments, and a host of considerations on interacting magnetic fields. The conclusion was that it is possible to drive the hot resistance of 1×10^{-3} ohms negative 2 kv with the charge available in the EV. Finally, using the calculated capacity value of 10^{-13} farad, it was determined that the RC time constant would be about 10^{-16} seconds. It is harder to get a grip on the L/R time constant, but best estimates place it in the same range as the RC time constant. In any event we are pushing the boundaries of electron relaxation time in a metal, and negative charge is not easily enough dispelled for the EV to land. One of the prime considerations here is a real possibility that the electron density for the EV is as great as that of the solid metal electrode, but that the mobility could be higher in the EV. This would severely tax the metal to maintain suitable fields for the EV landing.

Measurements strongly suggest that, when the EV is starved for electrons by even so simple a geometric trick as providing a foil rather than a massive block of metal, X-rays will not be generated; instead only a strong electromagnetic pulse will be generated. Notions for making such a picopulser are included in the chapter on components and devices.

Ions and Electrons Together

The photographs presented up to this time have largely been concerned with electron images from the pinhole camera. The rest of this chapter is devoted to presenting information obtained on both electron and ion images, using the EV to stimulate various structures and then viewing the result with the camera. The first structure to be presented is an EV run on a resistively-coated dielectric surface that can have a gas introduced near the surface while the entire apparatus is operated in vacuum. This gas EV guide was shown in Figure 3:19, and some of its operating parameters were discussed in Chapter Three. Figures 4:36 through 4:49 contain data pertinent to the use of this guide.



Figure 4:36

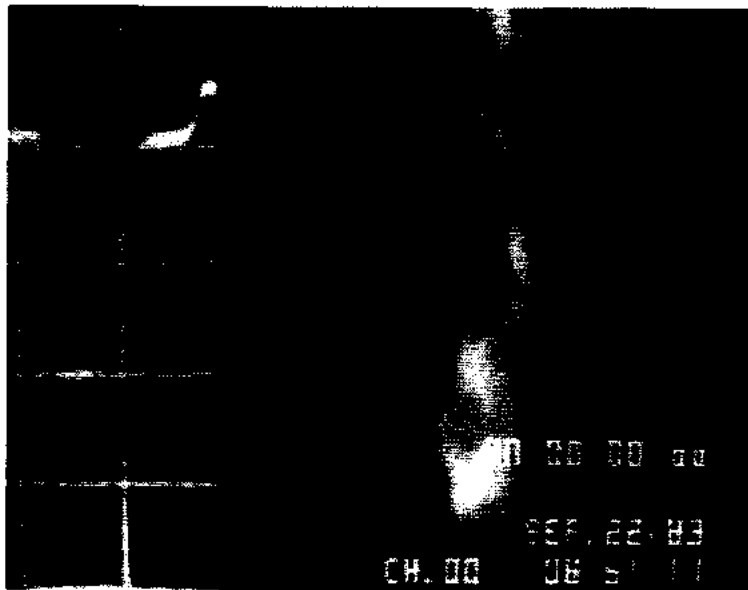

Figure 4:37

In Figures 4:36 and 4:37, the camera is trained on the source region at the lower end of the photo. The white lines show the path of the EV by picking up the image of the emitted electrons. The magnification of this photo is reduced from the values used in calibration by pulling the camera further away from the surface to get a photo of the longer path of the EV. The maximum distance from the EV source at the bottom of the photo to the target is something like 1 cm; only about half of this path shows in the photos just mentioned. The voltage waveform for producing the EV is also shown on the left side of the photo. The pulse length is about 1 microsecond and the vertical calibration is 2 kv per division, giving about 4 to 6 kv for firing the source, depending upon the value of other parameters used in the source.

In these two photos a high degree of wandering and disturbance is evident. This is usually caused by low gas pressure and a rough surface. As mentioned in Chapter Three, the EV is disturbed by surface irregularities but the gas pressure can lift the EV above such disturbances if the pressure is high enough. This series of shots was designed to hit a target of silver painted on the surface; the gas pressure had to be kept low enough for the EV to find and hit this target. At high gas pressure the EV just sails over the electrode and is off for somewhere else out of view of the camera.

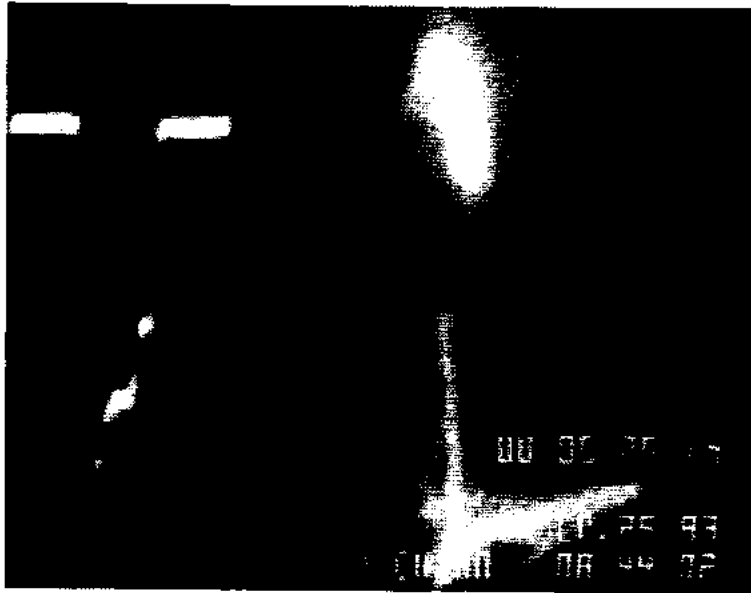

Figure 4:38



Figure 4:39

Figures 4:38 and 4:39 are views of the EV run in the region of the target anode. This view is obtained by simply manipulating the camera in the y-axis until the anode plume comes into view. In these two shots the path of the EV can be seen approaching the target at the top. The EV path is the thin line, and the target is the oblong bright spot at the top. These photos are obtained at low gas pressure, and without any voltage applied to the deflection plates within the camera. As will be shown in the next series of photos, the anode plume is a plasma of ions and electrons formed when the EV strikes the anode.

In Figures 4:40 through 4:47, the deflection voltage is first raised, and then lowered in voltage, giving the ions and electrons separate directions of deflection in the camera. In actual operation the spectral data is taken about every 1/3 of a second, or as fast as the TV camera can recover from the previous shot, to form a nice series of photos of which only a few are presented here.

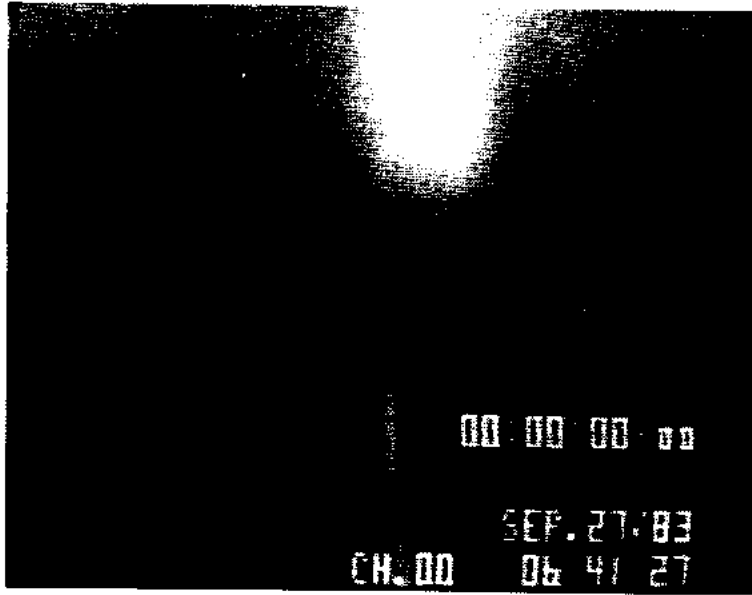

Figure 4:40

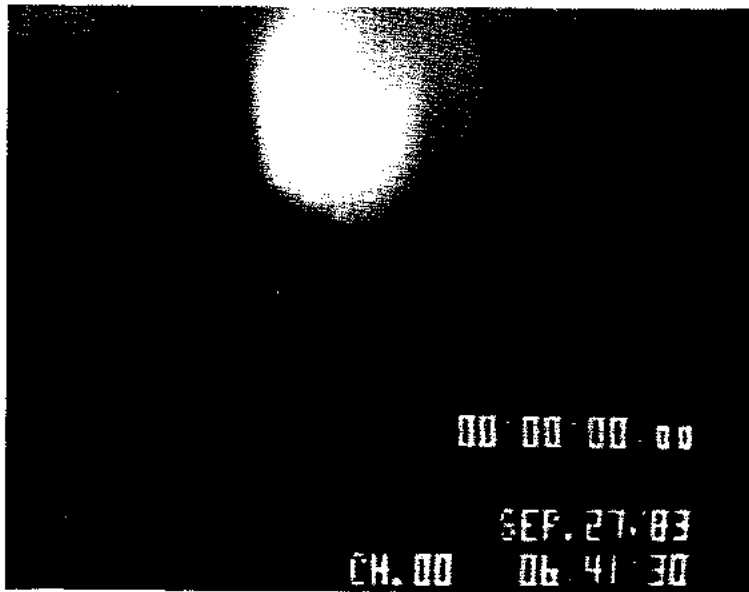

Figure 4:41

Black EV Strikes

In Figure 4:40 the EV is seen approaching the target area, but then fading from view. As far as I know the target was hit, and in all likelihood the EV seen approaching the target did the hitting, but for a brief moment it disappeared. There was a low extraction voltage (about 100 volts) applied to the camera to help clear the image of the fogging produced by low energy electrons. This may have somehow also removed the ability of the EV to produce an image in the region of the target. This is just one of the experimental things that gets away from me once in a while.

One item of interest in all of the photos that follow is the structure showing in the ion cloud, or plume, at the anode. This usually carries details that are very similar to those of an EV path, but they are shown as positively charged structures throughout their lifetime. Although I am certainly used to seeing EVs suddenly pop out of a cloud of plasma, I cannot say that I have pinned down this effect.

In Figure 4:41 the explosion of the anode is clearly evident, but the EV trail is not visible. In this view the deflection voltage has been raised very slightly, as can be seen by the slight displacement of the ion cloud to the left. There is also a very faint image to the right of the main blast that is in the correct place for electrons of moderate energy. Very low energy electrons would have been swept far off to the right.

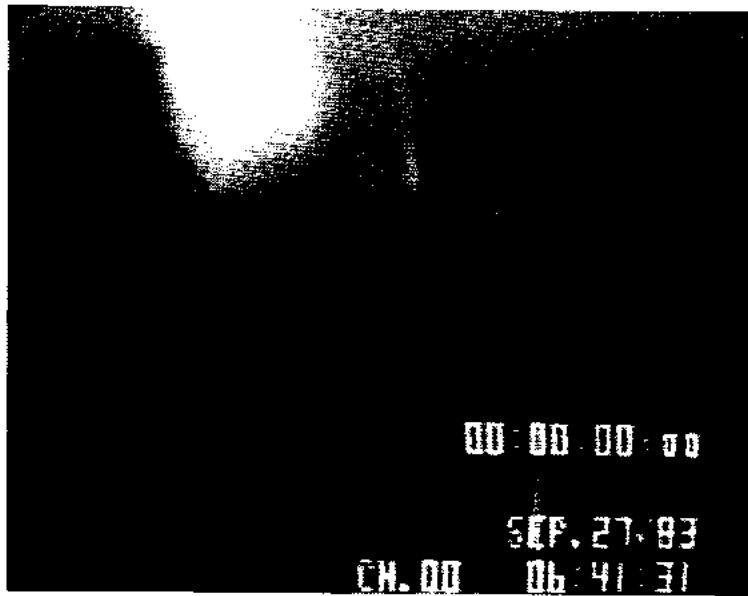

Figure 4:42

Low Electron Energy Spread

Figure 4:42 reveals much more information in that the EV input streak can be seen clearly, and it is displaced to the right of center as it should be. Notice that the energy distribution of the EV streak is as narrow as the unanalyzed EV path that shows on earlier photos. The emission energy from an EV is thus similar to a well-characterized emission line, and is not totally degenerate. The ion image in this photo is well deflected to the left, but has a hint of structure showing at a smaller deflected value. The shape of this structure will be seen in later photos, it is possibly related to the shape of the anode target.

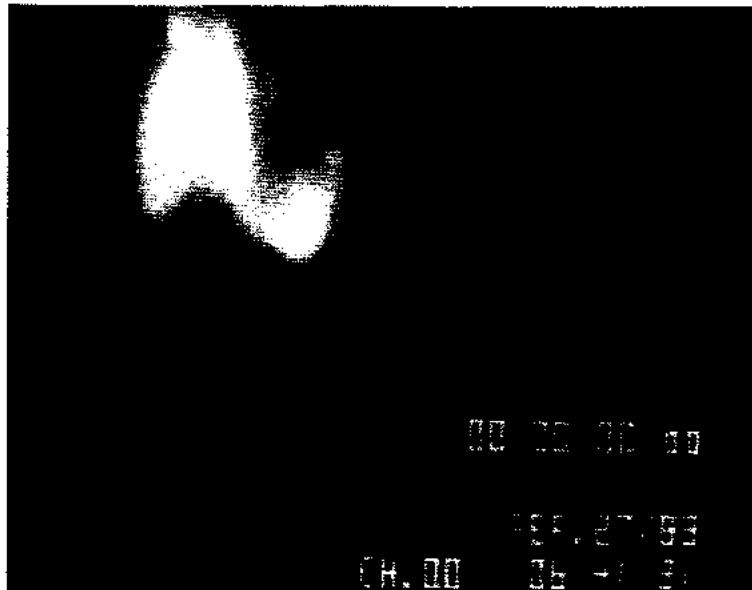

Figure 4:43

Figure 4:43 is somewhat similar to Figure 4:42, except that the EV trail is totally missing. One thing worth considering is that the deflectors in the camera are capable of a little bit of mass analysis, if the ions delivered to them are not accelerated by a common voltage. This is a possibility in the complex ionization system used here.

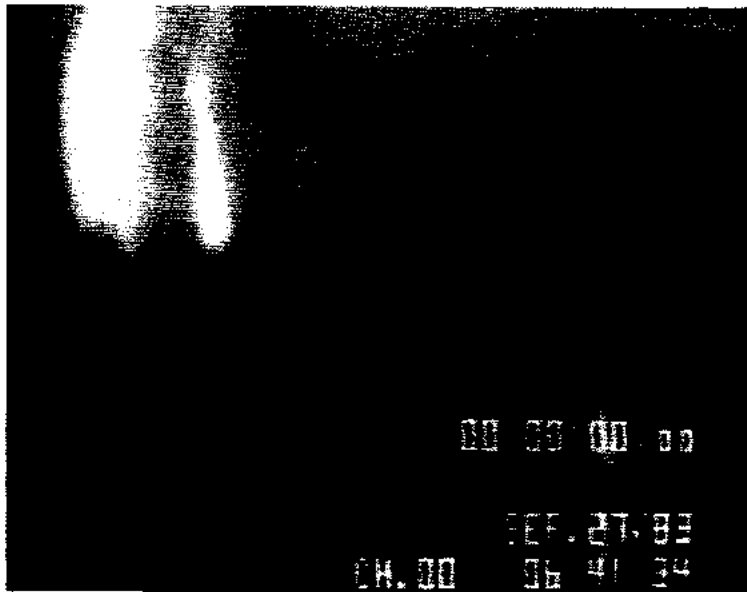

Figure 4:44



Figure 4:45

Figure 4:44 shows the approaching EV fairly clearly, and it goes all the way, or I should say *they* go all the way. Several paths can be seen coming in, and it is not possible to figure out what is happening. Obviously the deflection voltage has been raised to a higher value than the last shot, There is a lot of structure in the ion image that could be a result of the multiple arrivals.

Twin EVs or Dual Energy Levels?

Figure 4:45 shows something very interesting in the EV track--the twin trail that seems to be real. In addition the electron image, now deflected far to the right, has taken on the shape of the anode electrode as if it were looping around the electrode before going in for a landing. This loop later will be seen in complete form; here it only partially shows. Again, the EV energy distribution is narrow considering the deflection voltage applied. The twin trail may be a manifestation of two energy levels in the EV. This question could be answered if the loop had continued around the top where the deflection would not provide a separation.

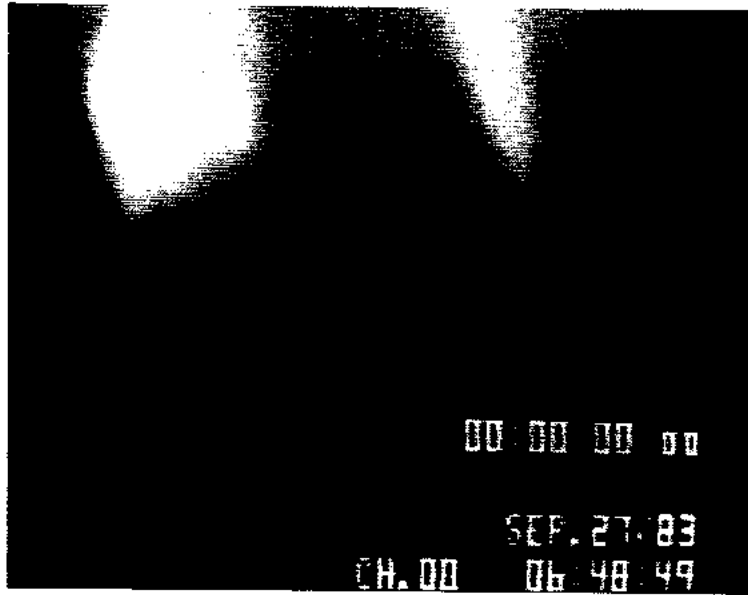

Figure 4:46

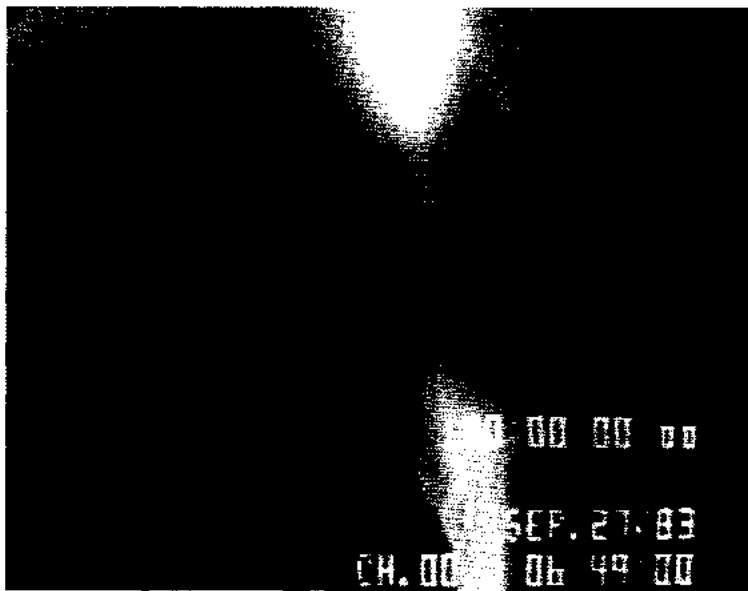

Figure 4:47

Neutral Emission

In Figure 4:46 there is another phenomenon that happens only about 1% of the time. In addition to the ion cloud showing, there is a bright streak at the neutral position. I believe this is an image of an X-ray or UV production site. As I have stressed before, the EV will dump its energy as X-ray only under certain conditions associated with the anode. When marginal landing conditions exist, the X-ray production effect is intermittent. Sometimes the EV finds a good spot and sometimes it does not.

In Figure 4:47 the deflection voltage has been turned off and the deflections have gone away. Several EV trails can be seen coming in, but only one can be seen going to the target.

Gas Pressure Effects

In all of the above shots the gas pressure was kept fairly low, possibly in the 10^{-3} torr range near the surface, to facilitate hitting the anode target. In this range the EV leaves a faint visible light image as viewed by eye, and, as has been shown, an electron image that varies somewhat. When the pressure is raised, the visible light image fades out completely and the target cannot be hit because the EV is essentially shielded from it by either a polarization effect in the gas, ions, or what-have-you. This mechanism is not clear.

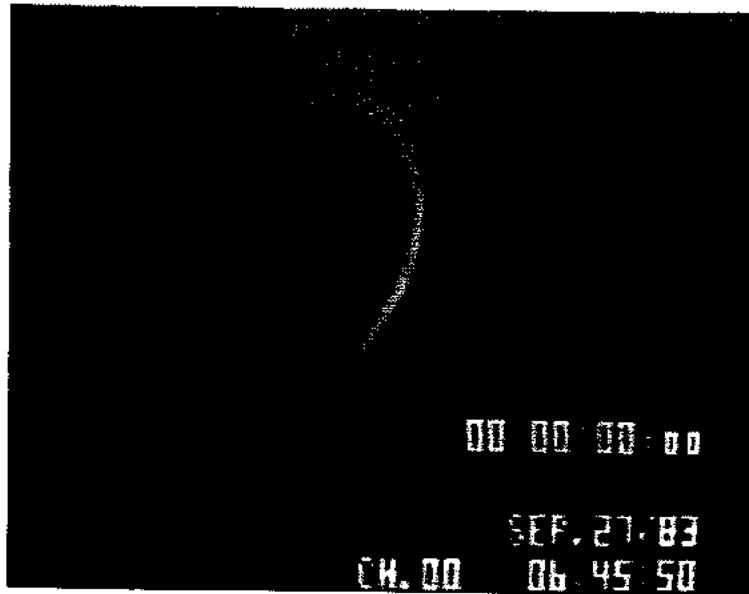

Figure 4:48

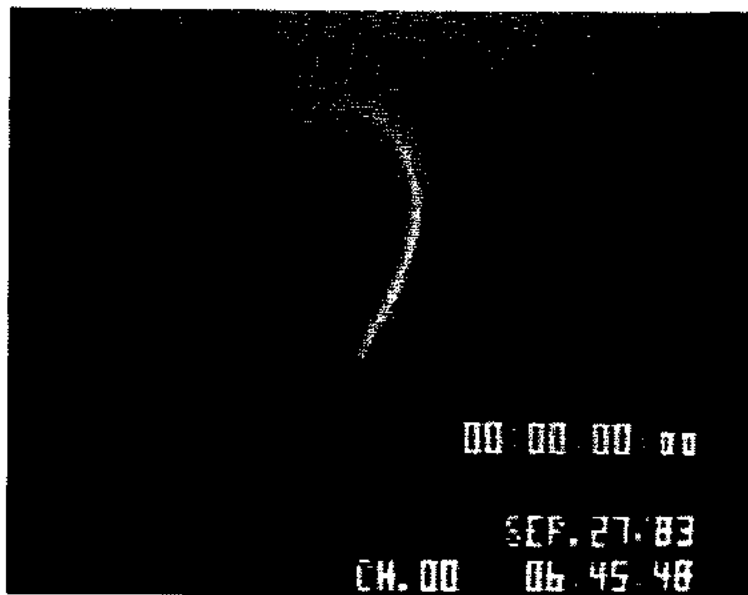

Figure 4:49

During a certain transition pressure range, the images of Figure 4:48 and Figure 4:49 are produced. What shows is a loop of charged particles having a positive sign. This loop can be repeated hundreds of times; it seems to have the shape of the anode and to be centered on it. Where is the EV coming from and where is it going? The reason that electrons from the plasma, which are presumed to accompany the ions, are not visible might possibly be the application of a low-voltage bias to the camera, mentioned earlier. At a slightly higher gas pressure the loop fades from sight and the EV has nothing at all to do with the designated area; it goes off to some place of its own choosing.

A Small Tube, End On

The remaining photos in this chapter, Figures 4:50 through 4:58, represent an attempt to photograph something with the camera that is somewhere in between the pure EV type of experiment and something more standard, such as a plasma system. The configuration used for this series is a fused-quartz tubing with an inside diameter of 0.15 mm and a length of 50 mm. The outside of the tube is surrounded with a metal to act as a counter-electrode or anode, but the end of the fused quartz sticks out about 1 mm past the metal covering. A cathode of mercury-wetted copper is used in one end of the tube; this end is virtually sealed by the copper wire. The entire apparatus is operated in vacuum and the camera is positioned to view the discharge straight down the open end of the bore.

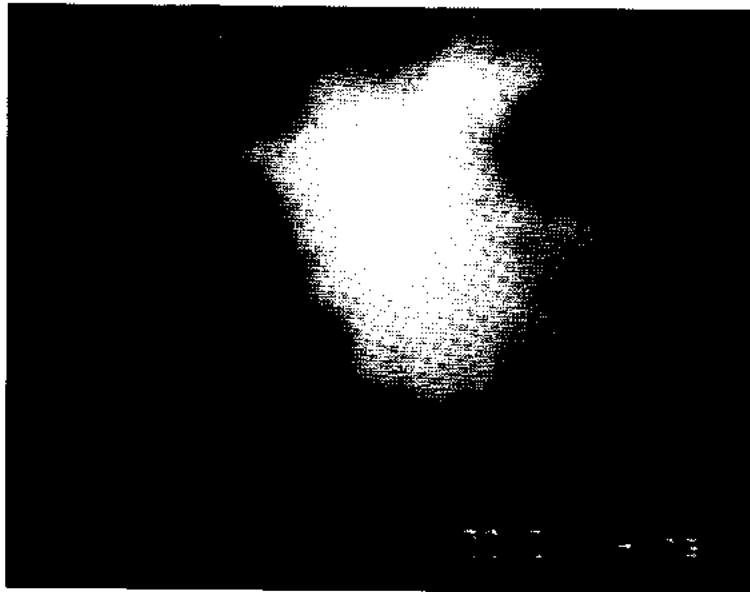

Figure 4:50

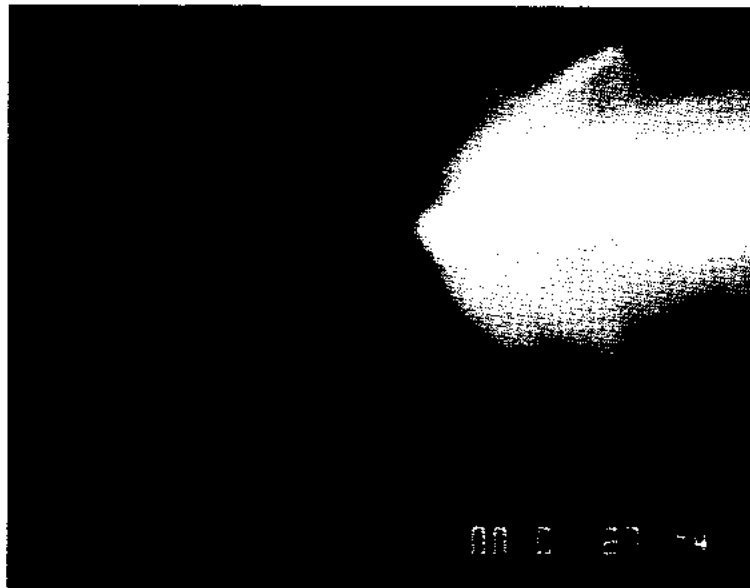

Figure 4:51

When the apparatus is first turned on, without any special extractor or deflection voltages, an image such as the one in Figure 4:50 is obtained. In this photo the only peculiar thing is that the emission is somewhat stringy instead of being homogeneous. This could be caused by any number of things, not the least of which could be droplets of mercury blown off of the cathode during the discharge, leaving an electron track from thermionic emission. This is probably not the case here, although it certainly could happen. By applying a voltage to the deflection plates, it is obvious from Figure 4:51 that the image is made up of electrons, and they seem to be hanging together in some way reminiscent of standard EV behavior, but the effect is weak and could be easily passed by. The absence of ions in the image also shows here. This is caused by the different sensitivity of the channel multiplier for ions and electrons. It is assumed that since charge neutrality is more-than-likely the rule, the number of ions and electrons emerging from the tube is equal. I also assume the predominant ion seen is mercury, although no mass analysis has been performed on the discharge.



Figure 4:52

Figure 4:52 shows a shot taken at higher gain so as to see the ions, as well as a central image that cannot be deflected with the voltage applied to the deflectors. The electron image is in full saturation and very little detail is available. The remainder of the photos in the series were taken with progressively lower voltage on the deflectors to show the images of ions and electrons coming together toward the undeflected center spot. In this series the details in the ion image are interesting, but I have not been able to get any significant information from them.



Figure 4:53



Figure 4:54



Figure 4:55

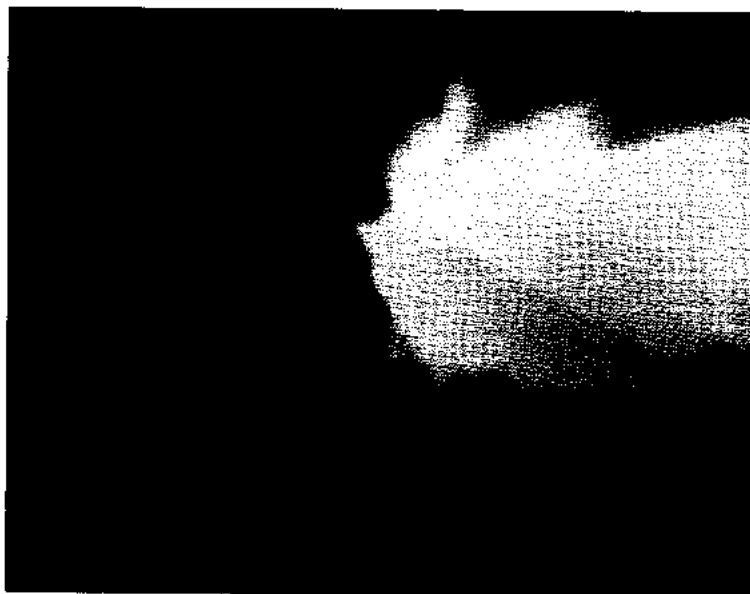

Figure 4:56



Figure 4:57

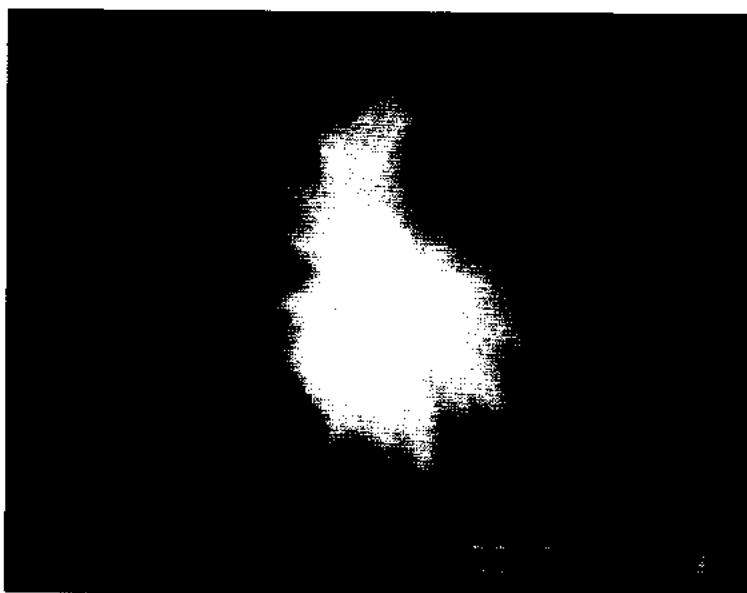

Figure 4:58

The Search for Ions

Since one of the most nagging questions in all of this EV work asks what holds them together, I have constantly kept my eye on the ion quantity and type produced around an EV. Whenever light is produced by an EV going across a surface, possibly there are also ions produced, but the numbers of electrons available are far in excess of the ions. It is possible that with the negative charge laid down on the surface by EV decomposition, the ions are drawn more strongly to this nearby charge than to the camera. Whatever the reasons, a strong ion image is not usually available. There are times when just simple experimental error, or bad experimental technique, will obscure some interesting observation. For example, the images in Figure 4:48 and Figure 4:49 were so interesting to me I may well have optimized the image, subconsciously, and rejected the foggy cloud of electrons that may have existed near the image (and held the clue to other mysteries about the process). In many of these experiments the statistical nature of the process precludes an easy return to the same data so once that shot is fired it is gone forever.

In spite of these missed approaches to answering the ion questions, there are still many trials where conditions should have been right to see ions in the EV structure with moderately high sensitivity. One such approach is to launch the EV into vacuum and look at it with the camera set to optimize ion collection by applying the proper extraction voltage and polarity to the camera. Both end-on and sideways analysis has been done on EV tracks by this method. It is usual practice to turn up the CEM gain higher and higher as the extraction voltage is being raised for ion collection. At a fairly well defined point, the electron image of the EV track disappears very cleanly because of the limited energy of the electrons (usually about 2.2 kv) and then the CEM gain can be turned up all the way. With some risk of breakdown, the CEM can be operated at a gain of 20,000. Under these test conditions every other gain is turned up maximally. When this is done the detection limit of ions calculates to be at least 10^{-5} of the electron density. With a little stretching it can even be said that ions are not present to within even one ion in a million electrons. That seems unusually low to me, just from the standpoint of accidental involvement. There is still some mystery as to why ions do not seem to show themselves if they are present. This is somehow tied to the often repeated observation that an EV can go through a low pressure gas near a surface and leave neither an optical nor electron trail as evidence of passage.

The notions to follow may be a little too philosophical, but this is not a bad time to record such notions. Suppose, for some reason not yet understood, the EV really is a tightly-bound group of negative charges with the density implied by the measurements. Inside this array we might say there is a tendency for like charges to attract each other, at least to within certain limits. Does this not imply that for some distance around this "reversed coulomb region" there is a region where unlike charges might repel? Farther away from the EV container there would be the normal effects of unlike charges attracting each other again. I don't know why anything would behave this way, but then again, I do not know why EVs do what they do. Whenever one rule seems to have been broken, it is likely that you will find another broken rule somewhere nearby.

Summary of EV Properties

The following list summarizes ten properties of the EV revealed by the pinhole camera.

- 1) The diameter of the largest charge-emitting structure tested here appears as a visual trace shown on the screen and is 1/22 of the full screen width of 0.1 inch as referred to the object. This is an apparent width of 10^{-2} cm, or 200 micrometers, at the object. This dimension is not consistent with the witness plate marks showing bead-chains with a diameter of 20 microns, or 2×10^{-3} cm, but there are many ways to make an image look larger than it actually is, and we may have some of these at work in this apparatus. Space-charge repulsion and scattering around the outer regions of the EV could easily account for this loss of resolution.
- 2) It has been shown that the residual charge carried by a 3-micrometer-diameter EV striking an electrode is 2×10^{10} electrons and that as many as 3.5×10^{14} electrons can be given off by a 10-micrometer-diameter EV over a flight path of 1 mm. The charge density from these considerations is in the range of 6.6×10^{23} electrons/cm³. It is not known whether an EV gets smaller in flight as a result of shedding electrons or not, but there are indications that some EVs may actually explode in space once a lower critical charge, and perhaps charge density, is reached.
- 3) The velocity attained by an EV under applied fields indicate the charge-to-mass ratio is similar to that of an electron.
- 4) Deflection of the EV by fields of known polarity shows that it responds as an electron.
- 5) Tests on the ion content of an EV attest to an upper limit of one ion per 100,000 electrons.
- 6) An EV is capable of being excited into emission of a narrow band of electron energies by various means including electromagnetic excitation.
- 7) Sudden destruction of an EV causes copious emission of X-radiation.

- 8) An EV can be transported without emission of electrons or photons.
- 9) The charge of an EV can be dumped suddenly on an electrode causing a large time rate of change of voltage on that electrode.
- 10) Coupling between adjacent EVs produces quasi-stable structures.

Reviewing the above list of EV properties makes me very glad that I finally got around to trying the pinhole camera. The camera has indeed produced an outpouring of information on the properties of an EV, and a lot of time was saved by using this qualitative instrumentation approach. In a later phase of the work we will fill in a few of the blanks left open here.

The last EV experiments to be done in Pescadero, California, were made on October 14, 1983. After this, to avoid the oppression caused by living in the California Coastal Zone where government permission is needed to do almost anything, the laboratory and my home were packed up for a move to Texas.

Chapter Five

EV TARGETS

This chapter gathers together an account of various events that do not fit neatly into the foregoing chronological narrative. For most of this data, I did the work at Pescadero; where there are exceptions I have identified where it was done and by whom.

No Conductivity; No Strike

In May of 1983 there was much concern about the shape of an individual EV bead, so some tests were done in vacuum to see if a high-resolution witness plate would reveal more about the EV structure. One of these tests consisted of firing EVs into a target of thin film material from a source with good aiming ability that could put an EV shot group within a 20-micrometer diameter. The usual target was a solid material, but these results suffered from poor resolution and I thought a thin film target would be better. Such a target was fabricated by using a standard 200-mesh copper-grid electron microscope specimen screen as the base. This held a thin film of carbon with chromium deposited on it to a thickness of about 500 angstroms.

This grid was put into the anode witness-plate holder of the apparatus and EVs were fired at it, one at a time. Much to my surprise, I could not hit the center of the target at all. The center is the diamond-shaped region shown in Figure 5:1. Even after nearly a hundred shots on one screen, all that I could hit were the copper bars of the grid, and these shots were scattered all around the center for which I was aiming.



Figure 5:1

On one of these grids, shown in both Figure 5:1 and Figure 5:2, a strike did manage to hit the edge of the film enough to break the film in the center. A careful inspection of Figure 5:2 reveals about three EV strikes on the copper grid as well as a barely-visible splash at the lower edge of the broken screen hole that is responsible for the broken film.

My interpretation of this is that the chromium film is so high in resistance that the voltage on the film is driven negative by the approaching EV, thus making the film an unattractive place for the EV to land. This kind of argument is very much in line with the discussion in the last chapter on how the electrons are unable to be supplied by even a relatively-massive aluminum foil. When the EV cannot land on the center of the grid (where it was aimed), it must turn within the last tens-of-micrometers and hit the copper grid bar.

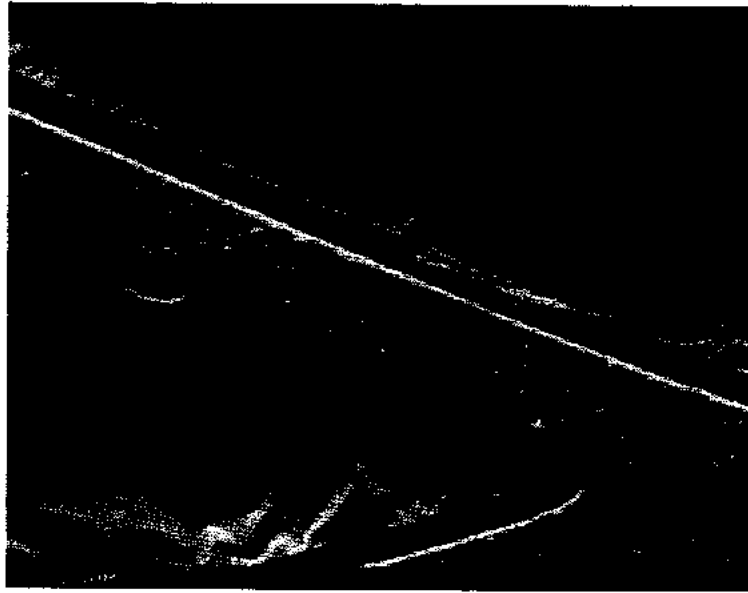

Figure 5:2

Conductive Backing Plate

An important factor in the above experiment was that the copper grid was mounted in a holder that did not provide any conductive backing for the grid. The grid was held at the edges only. In the next experiment, a conductive backing was provided in the form of a removable plate of titanium, one of the oldest witness plates used, and this plate was closely coupled to the copper grid. What was seen after a single EV shot is shown in Figures 5:3 through 5:5.

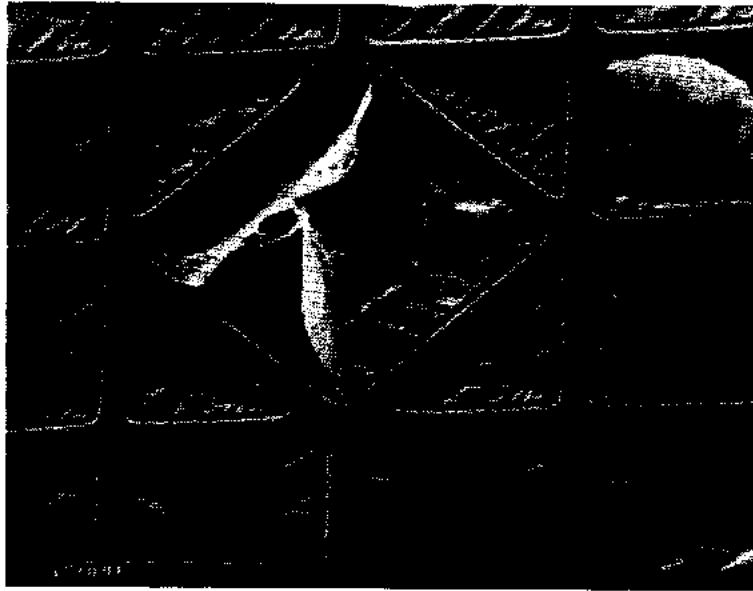

Figure 5:3



Figure 5:4

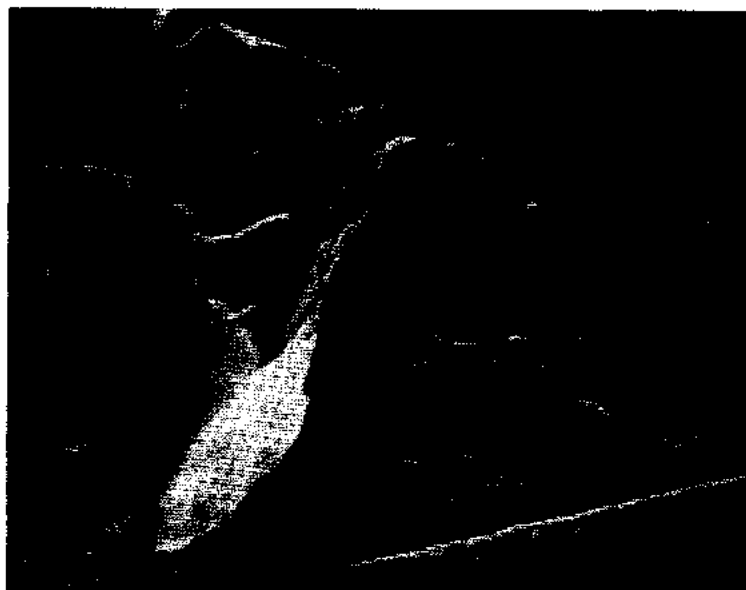

Figure 5:5

By looking through the blown-up film material, it is possible to see an EV strike on the backing plate. This mark is typical of an EV strike on a titanium plate. It has the classic milk-splash structure associated with it in which a central core of material rises up, and then falls to one side or the other, finally freezing in place. It is remarkable to me that the structure of the EV is maintained after penetrating the film of chromium and carbon. Notice also that the carbon is attacked less than the chromium. The type of destruction produced here is not so much that of a bullet-like thermal process, but rather one of a miniature bolt of lightning where the film is destroyed at great distance by a violently active assassin, who escaped largely unscathed.

Thin Carbon Target

The attempt to increase the resolution of the witness plate had failed, but I attributed the failure more to the presence of the chromium than to the presence of the carbon. I attempted to rescue my high-resolution aims by using a film of carbon without the chromium. Normally I would have considered this futile because of the negative field the EV would have induced into such a high-resistance material, but I began to see the light from the backside of the problem. In some respects, an EV is interested in high resistance materials (as evidenced by their attraction to dielectrics), possibly through the polarizability of this class of material. In any event I must have thought a carbon film looked more dielectric than metallic to an EV and so decided to give it a shot.

A carbon film about 100 angstroms thick was mounted on a copper grid in the recessed holder, and several shots were fired at it. The grid was inspected in both an optical microscope and the SEM, but nothing really interesting showed. This is one of those times when intuition has to be trusted, and mine told me to put a high-resolution transmission electron microscope on this inspection job. I do not have a transmission microscope, so I bought some time on one at Stanford University, and looked at the films. It is a tedious job to look for a low-contrast object on a background of about the same density and so I spent quite a bit of time scanning around. Several funny shapes kept coming up in the region where I had bombarded the film, but I kept passing them by. These shapes were simple little rings that were slightly darker than the surrounding material. They happened to be very close to one micrometer in diameter. Suddenly I found a broken film that had been rolled back due to strain and I got a sideways view of the effect that had been producing the rings.

What I saw is shown in Figure 5:6. This looks like an extrusion of the carbon film. It was going in the right direction for an EV to have passed through, and it is the right size for a bead, but how in blazes can one extrude carbon like this?

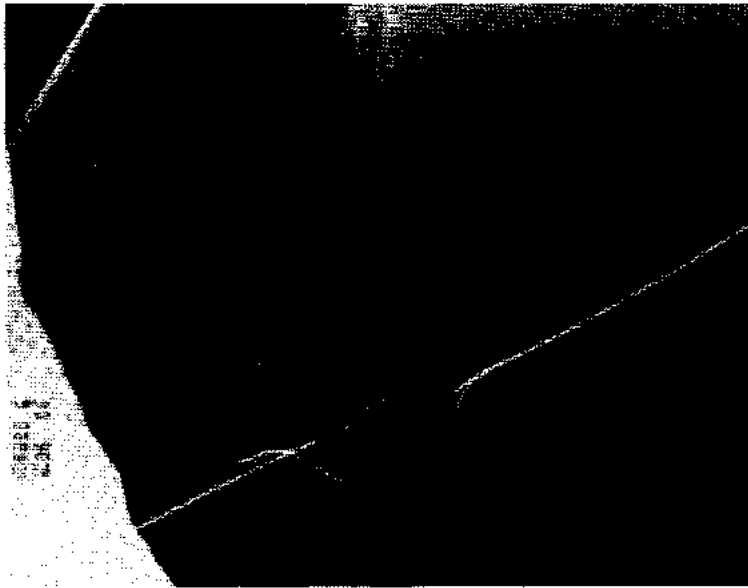

Figure 5:6

Once in a while I just have to accept something new, so I recalled that impact extrusion at high speed can extrude materials normally thought to be brittle. If all of this is possible, the EV that got through would certainly be filtered of heavy ions, although I cannot even be sure of that anymore. Unfortunately I did not collect the EVs used to hit the target. This was just an oversight, and there was no time to go back.

I am not sure whether this attempt to improve the resolution of a witness plate was a failure or not. There is no detail on the film of carbon that gives any clue as to the structure of the thing that passed through. Perhaps it was rotating and blurred the image. Perhaps this is all there is. We will return another day.

These photos represent the last of the targets that were used at Pescadero; the following work was done while the lab was being rebuilt in Austin, Texas. The work done on plasma streamers during this interim period was really low science, because most of my equipment and gadgets were still packed away in shipping boxes. The streamer-work proper is described in the next chapter, but there are some EV targets used in the work that I want to describe here while the memory is still fresh on what happens to similar targets in vacuum.

Strikes from a Tesla Coil in Air

All of the events in the streamer work are done in a gaseous environment, with or without metallic electrodes in the gas, and with a pulsed RF power supply. This power supply produces a burst of RF in the MHz range. Thus several complete cycles of energy are available to form both EVs and a sheath of ions that can cover and shield them, as well as supply a return current path to the source. Without elaborating further on the methods used, I do want to show the difference in the effects on a target witness plate.

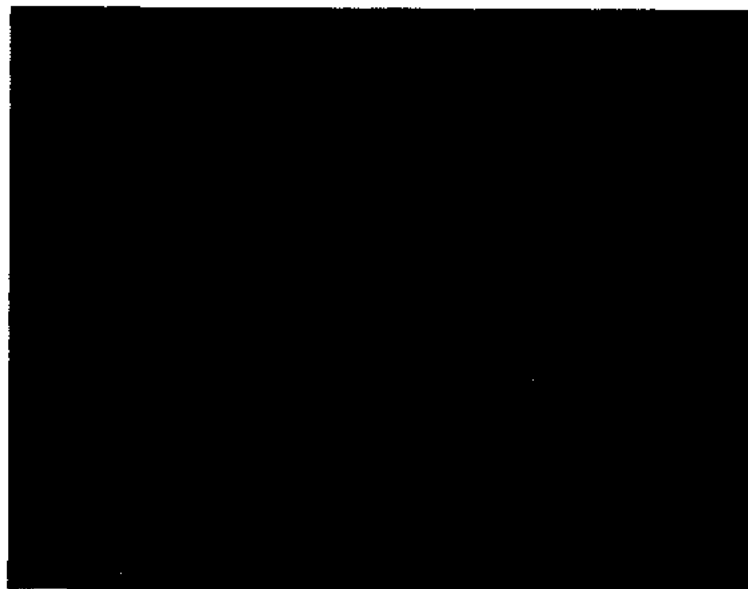

Figure 5:7

The strike marks produced in Figures 5:7 through 5:9 were produced in the most primitive way possible. A standard laboratory Tesla coil, normally used for finding leaks in a glass vacuum system, was allowed to strike a film of chromium on glass.

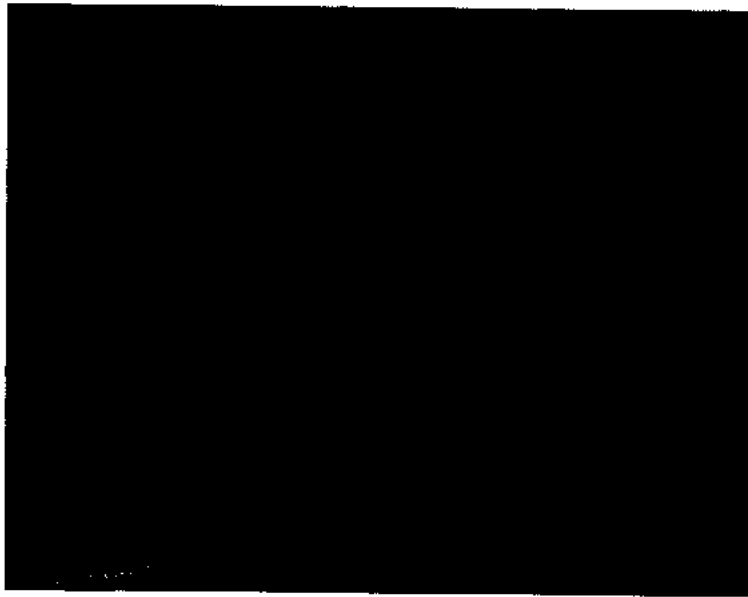

Figure 5:8

This was done at atmospheric pressure in air. What one sees visually is a thin blue streamer going to the plate, and a small flash at the plate. When this plate is viewed in a SEM, these photos result. Figure 5:7 shows a rather messy area on the substrate with some chips and scratches on it. It also shows three strike marks and some of the splattered metal from the strikes.

Figure 5:8 shows a single isolated strike mark with a small quantity of splatter. I show this because there is no really outstanding roughness on the surface to cause a cathode-arc crater or the like. I have constantly looked for such occurrences but have never found them. From earlier work I know that an EV goes where it is aimed. Even though the terminal guidance is strongly electromagnetic, the EV is not overly concerned about roughness or small points. In the photo a dark rectangular patch shows, resulting from contamination in the SEM. I just watched this spot too long.

Figure 5:9 is a magnified view of Figure 5:8 showing a very nice round hole; the ellipticity is due to the viewing angle of the SEM. It is an old trick to use a lab Tesla coil to pierce very small holes in thin glass for making micro-leaks. This is the mechanism that does that job. With the experimental setup used, there is no definite way to say whether this was an anode or a cathode. It is just a hole in the chromium film but it is very similar to other holes we have seen. Draw your own conclusions.



Figure 5:9

Strikes in Low-Pressure Xenon

To make just a little more science out of the above experiment, a discharge was carried out at a pressure of about 0.1 mm Hg in xenon. The power supply used was the pulsed 1.7 MHz burst generator mentioned earlier (discussed further in the next chapter). At this low pressure in xenon, the streamers are very thin, almost invisible, and seem to have no energy at all. Their strike mark is practically identical to the one just shown for 1 atmosphere of air. Figure 5:10 shows one of the most peculiar of the strikes obtained.



Figure 5:10

In this photo there are two strikes that must have occurred simultaneously; otherwise the film would not have been ruptured and lifted from the surface. The strike marks themselves are identified by the splatter that emanates from them. There is one strike near each end of the fractured shape. Figure 5:11 is a magnified view of the strike at the top of the fracture. It is the same old story; the marks look very much alike under almost all conditions of EV generation.



Figure 5:11

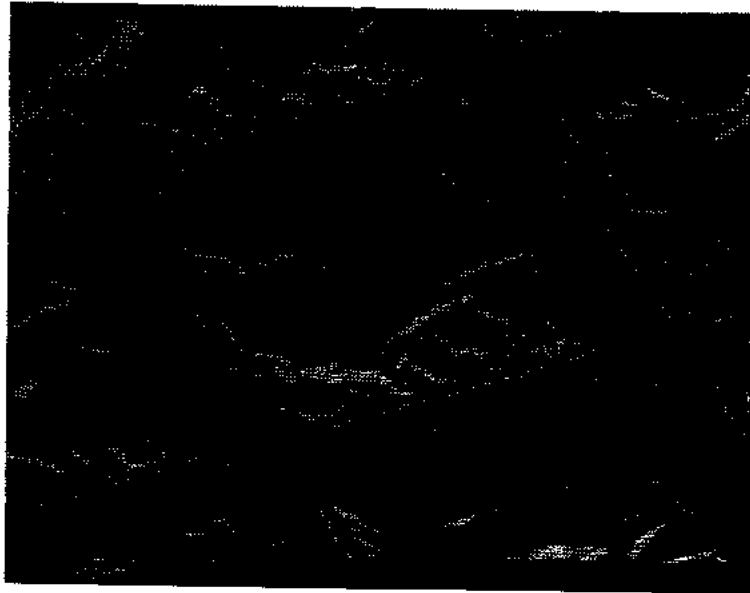

Figure 5:12



Figure 5:13

Difference Between Gas and Vacuum Strikes

Now for the real surprise. When a grid of copper coated with chromium, just like the one for the vacuum shots, is placed near the path of one of the low-pressure streamers, and a sufficient capacity is coupled to the grid by attaching a small wire, the streamer either ruptures and sprays EVs on the grid or the stream terminates totally on the grid, leaving the grid looking like it was hit with a load of bird shot. Figure 5:12 and Figure 5:13 show the low- and high-magnification SEM photos of the effect. By incorporating gas into the EV transmission process, it has now become possible to hit the low-conductivity films stretched across the grid with no trouble at all. It must be that the ion sheath that is presumed to travel with this kind of streamer somehow prevents the retarding field from building up on the films. Again, I wish I had caught the transmitted EVs on a high-resolution witness plate on the back side of the film, but I'll save that one for later too.

Scanning Tunneling Microscope Strikes

I was attending a field emission conference and discussing a scanning tunneling microscope with Mark McCord of Stanford University. In this conversation he mentioned having had a bad time, during his initial work with the instrument he was building, because of arcing or breakdown between his cathode and the specimen or anode. He showed me some pictures of his anode and cathode. As soon as I saw them I begged a copy of a photo from him because I recognized the signature of the EV again. The photo he gave me is shown in Figure 5:14.

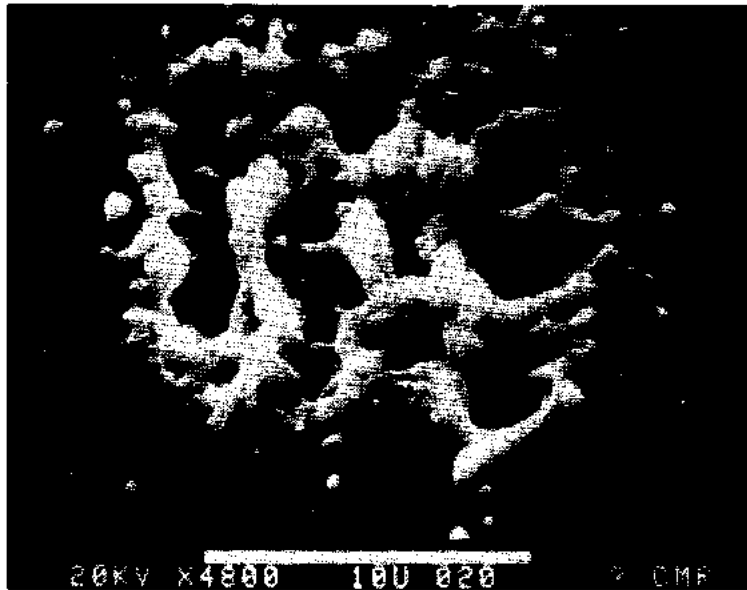

Figure 5:14

In McCord's work the cathode is a tungsten point and the anode is either pure silicon or gold-coated silicon. The scanning tunneling microscope manipulates the two electrodes to within a few angstroms of each other, and then scans out an image of the surface. If the voltage is much above 25 volts, the arcing problem is prone to happen.

What is showing in the photo is a series of explosions at the anode that have occurred as the raster pattern is scanned. Each crater is very much like an EV impact, and a large quantity of material is thrown out of the crater. The cathode, a tungsten point, is initially blunted but then withstands many more of the withering explosions without much change.

I comment on this because I am interested in discriminating between the so-called cathode spot and an EV anode strike. I have almost come to believe there is no cathode spot, just an electrode that momentarily looks like an anode to an EV, and gets hit.

Most of my notions for this potential reversal effect come from data others have taken on the unipolar arc produced by laser irradiation. Fred Schwirzke, of the U.S. Navy Post-Graduate School at Monterey, has published a lot on this effect [Schwirzke, 1984].

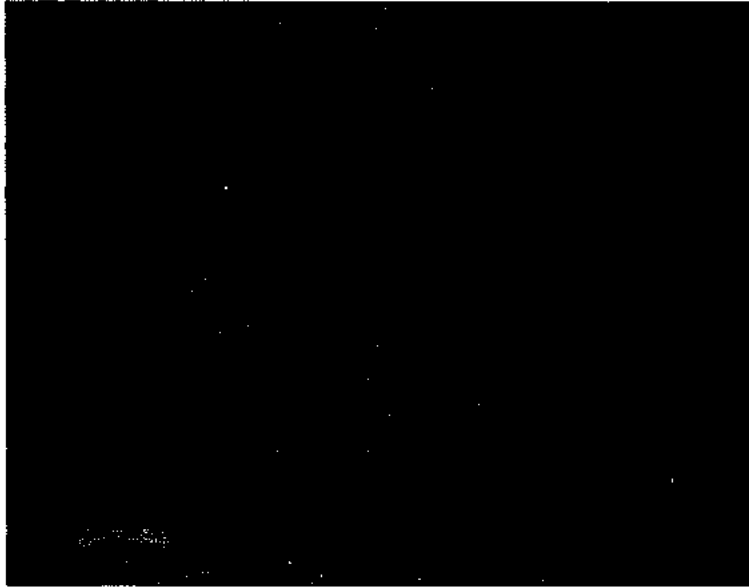

Figure 5:15

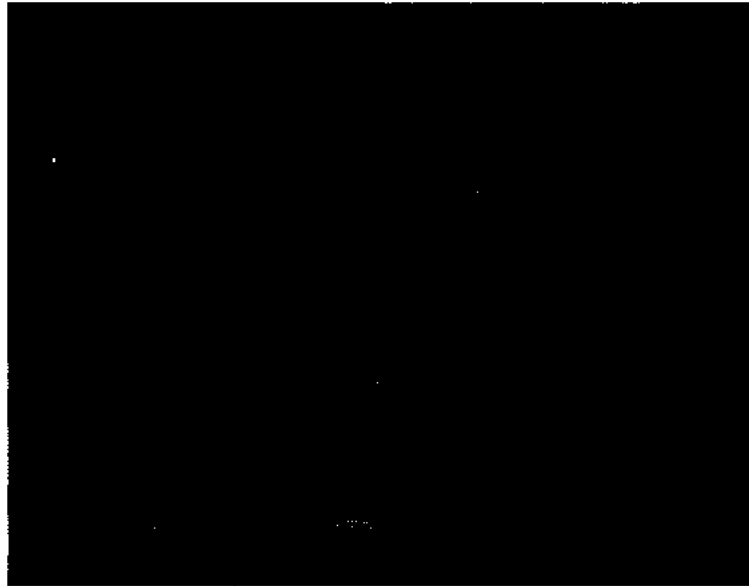

Figure 5:16

Field Emission Diodes

As a final planar type of target in this series of EV targets, there is the unwilling target shown in Figure 5:15, and magnified in Figure 5:16. These are SEM photos of field emission diodes made by C.A. Spindt at SRI International. The photos show what is left of a beautiful array of field emission diode emitters after some kind of electrical breakdown occurred. In the testing of these arrays, it is typical to apply up to 50 volts on the top electrode, or anode, that shows most easily in the photo. If you look carefully, cathodes or emitter tips can be seen in the small holes. My interpretation of the blowup is the same old song. EVs were formed when the current density became too high, perhaps during breakdown, and then they jumped on the top anode film. The witness marks are not great-looking marks, but they do have some of the right characteristics. What is evident here, and in many of the low voltage EV generators, is that the EVs seem smaller in size.

What a universal creation process this EV generation is! How could it have remained hidden for so long?

Boring Through Dielectrics

Another class of attack launched by EV structures is formed in dielectric materials that have a field across them. I am sure there is a field across almost anything that an EV approaches, but, in the case I am about to discuss, the field is applied to the material in an attractive direction for the EV *before* the arrival of the EV. There are two general subcategories to the class of effects under discussion here.

Category one occurs when an EV is caused to run down a channel that is purposely made for its guidance. In the case of an EV made from a discharge of around one kilovolt with a metallic cathode, the channel width, or diameter, used is normally about 20 microns, not too different from some of the EV ring diameters that were shown in earlier photographs. Category two of observations is done on two plates of carefully lapped solid dielectric materials that may have a very small crack between them.

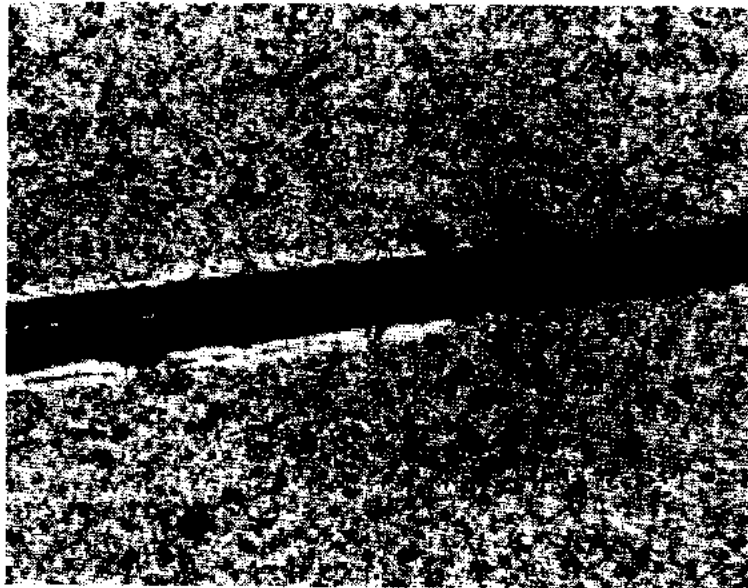

Figure 5:17

What can be easily seen in the first category of experiment is that, when a groove is slightly larger than the critical size for EV passage, there is no measurable effect caused by the EV on the guide structure. By reducing the guide structure only a few percent in width (for a rectangular structure) or diameter (for a round structure), the damage is suddenly catastrophic. The implication here is that the guidance is stiff and tight; the EV has a well-defined dimension and is quite stiff, as if it were a reamer made of very energetic solid material.

The following discussion is of work that was mostly done in 1986. Figure 5:17 shows an optical photograph of a channel of aluminum-oxide film material deposited by thermal evaporation by masking a 20-micron wire. The alumina is doped with tungsten to render it slightly conductive, so as to control charging. A molybdenum film was deposited about 20 microns under the channel to act as a counter-electrode or anode.

This type of construction produces a well-defined guide for an EV; doped alumina of at least 20 microns thickness is on 3 sides of the EV. Although the contrast is somewhat low in a black-and-white photograph, a region of EV attack can be seen on the left side of the photograph. This attack has evidently produced heating of the alumina, and subsequent consolidation. The right-hand side of the photograph of the channel has not been damaged by repeated use as an EV guide. There is only a very small difference in the size of the guide in the two regions.

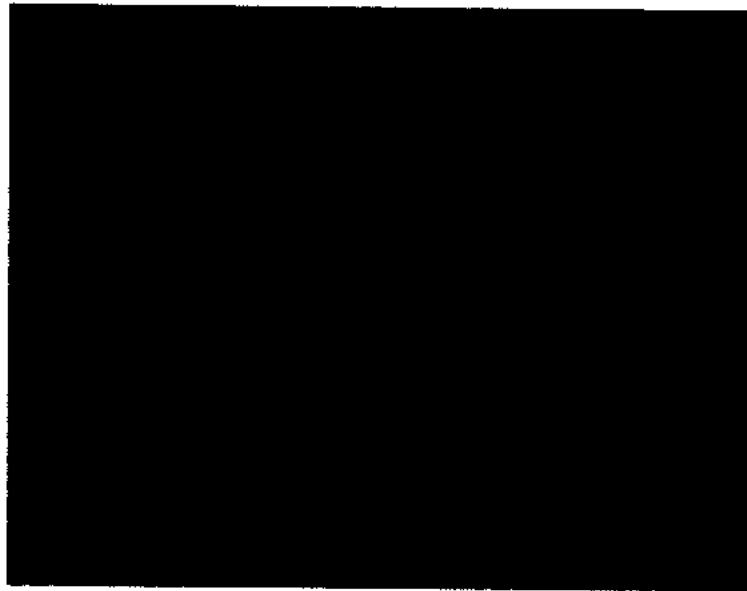

Figure 5:18

A cover plate of the same kind of alumina was deposited on glass, and is used to close off the top of the rectangular channel. In the particular experiment run here, the channel depth was not adequate and the cover plate was attacked by the EV. The result of this attack is shown in Figure 5:18. It can be seen that heating has produced shrinkage cracks in the alumina film.

In another instance (shown in Figure 5:19) the cover plate was first used on the left side for one experiment, and then again on the right side on a different channel. Obviously the destruction was considerable on the left side, but the right side of the channel cover was not fitted perfectly flat on the channel, and this caused the channel depth to be slightly greater in one place than another. Notice that the very slight taper of the cover plate greatly affects the health of the alumina film. In regions where the plate was slightly closer, the EV attack has consolidated the material and cracked it. Once a channel has been bored out by an EV, there is no further attack. Repeated EV firings, at any known rate within the limits of the R-C recharge of the channel, can be used without further change in channel properties.

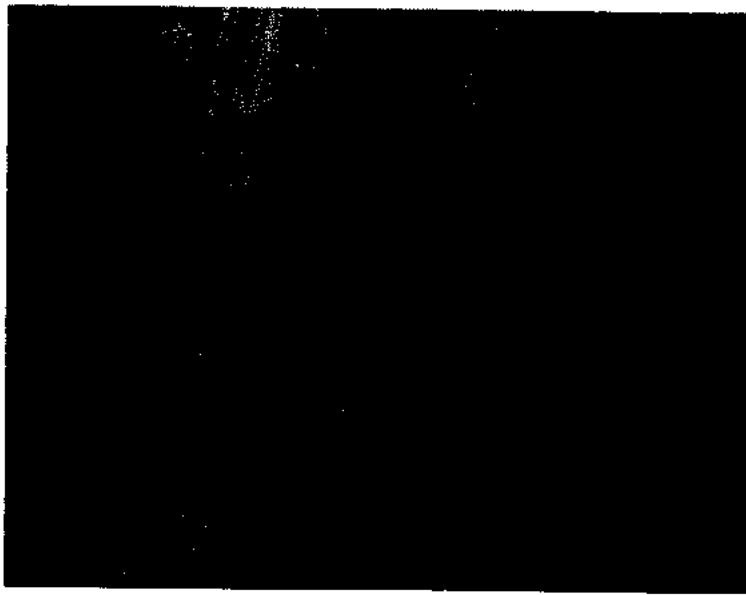

Figure 5:19

Reboring Small Channels

This rebores process can be carried out from an absurdly small initial channel size. In one particular experiment, an EV was launched into a channel (of only about 4 micrometers in width) that was mechanically lapped into one surface of a pair of 96% aluminum-oxide ceramic plates. A finely-lapped cover plate of 96% alumina was used to cover the small groove. The two units were wrung together and clamped, to produce a very small spacing between the two parts, perhaps less than 5 micro-inches.

A mercury-wetted silver cathode was provided within a small enclosure near the tip of this structure, so as to provide an EV source. A silver counter-electrode was fired on underneath. In addition, a grounded collector electrode was placed about 0.01 inches away from the tip of the ceramic assembly placed in a vacuum chamber.

When a single EV burst was fired by pulsing the cathode negative about 2 kv, a lot of sparks were seen to shoot from the tip of the ceramic. All successive pulses produced no sparks, only EVs that struck the target anode.

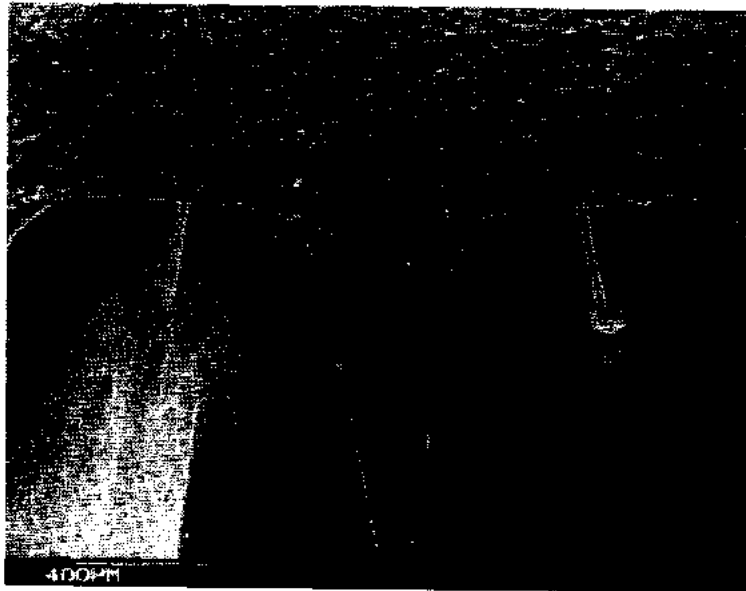

Figure 5:20

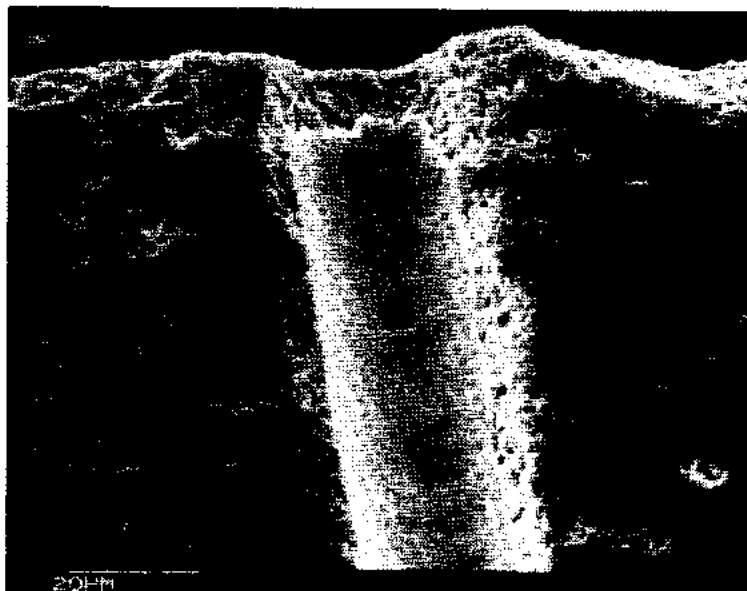

Figure 5:21

When the two plates of ceramic were taken apart and examined in an SEM, the photograph in Figure 5:20 resulted, showing the effect of the passage of the EV through the ceramic. A clean hole was bored in exactly the location where the 4-micrometer groove had been previously placed.

Notice that the ceramic part on the right has a groove starting at the small depression that had been provided as a dog house for EV formation. Before the EV firing there had been no marks on this polished surface. The EV had dug out a channel in both plates that, in just one passage, took almost all of the material out the way it went.

Figure 5:21 shows a magnified view of the end of the channel on the right side. As is typical of an EV attack on alumina ceramic, the smooth bore formed by vapor-deposited alumina is surrounded by highly disturbed alumina bits. I would like to know what kind of a beast it is that treats our high temperature and refractory material so shabbily!

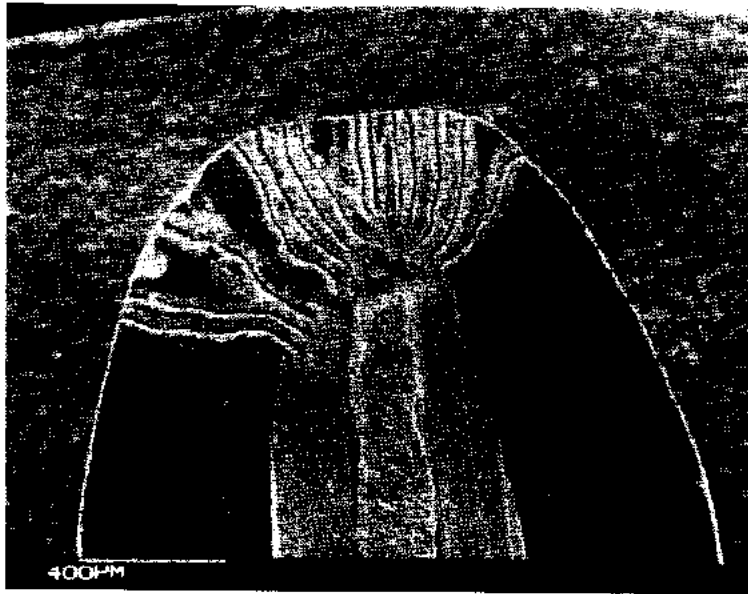

Figure 5:22

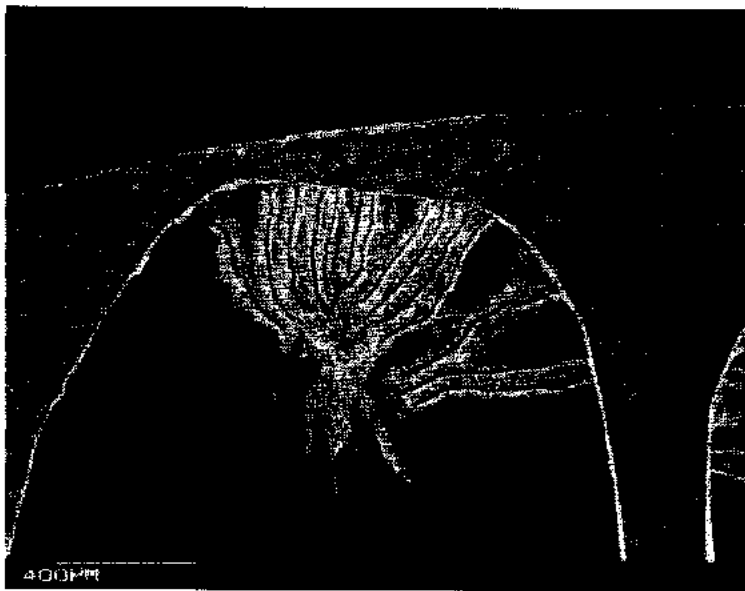

Figure 5:23

Multiple-Hole Boring

Even greater mysteries are shown next, by using two polished plates that are prepared as previously described except that no initial groove was provided, and the firing rate of the EVs was increased so as to allow no electrical discharge of the ceramic between the firings. Figure 5:22 and Figure 5:23 show a low-magnification SEM of the two halves of the ceramic, mirror images of each other. Notice the similarity of the channel sizes and the approximately equal spacing of the channels.

This kind of tracking has been seen many times on surfaces; the position of the track is caused by surface charging. It can only be presumed that a similar charging process is responsible for the uniform spacing of the channels here. The EV seems oblivious to the fact that the solid material is in its way. It just treats the sub-microscopic crack between the surfaces as if it were a free surface, and projects the material in the groove out with it. Assuming that the postulate of charge-control of the channel position is correct, it can be seen that there is a very high gain process at work here by which a little charge at the EV generation point controls the removal of a lot of very stable material.

Figure 5:24 shows a higher magnification of the end of one of the channel structures formed by the EV.

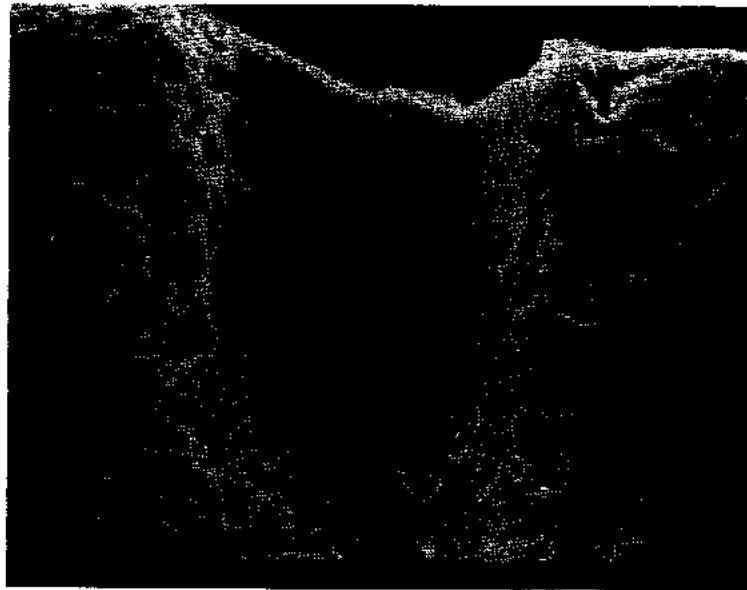

Figure 5:24

What appears to have happened in the formation process of the channel is that the EV passed through, in a very explosive and disruptive fashion, producing a lot of fractured alumina. There is also the possibility that a vapor of alumina was left behind after the EV passage, and that this vapor recondensed on the surface of the fractured alumina, leaving a featureless layer. This thought has erased all hope I had about finding telltale evidence of EV structure by analyzing the walls.

Momentum Transfer

In earlier work in channels, using mercury-wetted cathodes, it was occasionally observed that, under microscopic observation, a small bit of mercury (deposited on the walls of the EV guide channel) would consistently and slowly move in the direction of the EV passage toward the anode. It is thus reasonable to assume that some sort of drag exists, and that momentum of the EV movement is passed on to the walls of the guide and the material associated with it.

In the case of the properly-sized guides, there would seem to be very little of this momentum transfer. On the other hand, when a guide is undersize, or non-existent, at the beginning of the EV firing, the momentum transfer must be tremendous, because all of the material in the channel is blown out of the channel in the forward direction. This is not like the case where the entire line of material is just suddenly heated and ejected both ways. The material totally goes out the door with the EV.

Does the EV wait for all of that material to vaporize and then push it from behind? I think not. I believe the EV passes through the solid material without significantly changing the EV form, and then the momentum transfer yanks the material out after EV passage.

Container Distortion

Clearly we have encountered a very unusual effect here, and any attempt I make to explain it will be, in the main, wrong. In spite of this low probability for being correct, I am nevertheless going to comment on one of the mechanisms I think is at work here: I believe a form of radiation propulsion is induced in the EV by changing the shape of the normally symmetrical, fierce, electromagnetic container that *is* the EV. More is said about this in the chapter on theories.

Chapter Six

STREAMERS

This part of the story begins one Sunday morning in June, 1984, in Carlsbad, California, where I was taking some helicopter training at the Hughes Aircraft Delivery Center. I had just finished having breakfast at a small restaurant in one of the shopping centers and was walking out of the door when I saw a picture in a newspaper lying on the floor. The picture showed a clown looking at a large glass sphere with many streamers of electrical discharge in it. This sphere, as it turns out, was on display at the Science Museum in San Diego. It was only about 7:00 AM but I must have broken some records getting out of Carlsbad and into San Diego. I was far too early for the Museum to be open but I lurked around waiting for someone to show up. Finally I found an attendant and got to the curator of the museum. I arranged for a demonstration of the device and also got the name of the fellow that had put it together for them. His name was Robert Golka of Brockton, Massachusetts.

The characteristic of this device that immediately drew my attention was the high aspect ratio of the streamers. They were thread-like both in the gas phase and on the wall of the glass sphere that contained them. The streamers would follow your hand if you moved it near the glass. It made a very beautiful display of something I would have bet money, marbles, and chalk had to do with EVs. This was another one of those intuition points I could not let pass.

The problem I was having with the knowledge side of my mind was this: I was firmly convinced that EVs occurred at a metallic cathode, and at no other place. This device on display was obviously an electrodeless discharge operating on high frequency current, and was thoroughly in violation of my premise. I knew of no way in the world for a *gas* to get the electron density that I thought was required for EV formation. At this point I just had to sweep my knowledge under the rug and pay attention to what I was seeing.

By this time, in 1984, the lab had been moved to Austin, Texas, and was being set up to do microfabrication technology in exotic materials because that is what EV work demanded. It was a hard decision to get into this technology work because such work is usually either very expensive or goes very slowly. I was trying to get around these limits with some brilliant stroke of invention when this streamer problem appeared. The streamers offered some relief to the daily tedium I faced, and I suppose I jumped into it partly because of the fun and comic relief it offered.

One of the first things I did was to go back over the ancient literature. I mean way back into the eighteen hundreds, and sure enough, the old timers had seen it all. The problem I had with most of the publications was that the data was interpreted in terms of existing theories, and even the measurements seemed bent to fit the theories. None of what I found could be easily tied to the EV sort of problem I was working on. I am sure such data did exist, but sometimes data retrieval is harder than data regeneration. I started to regenerate data; it was back to the lab for me.

Pulsed RF Power Supply

Most of the good parts of the lab were either still in boxes, or broken, or lost, or so I thought. My working processes are such that I will not try to do good things in a chaotic environment. I am sure that in my mind I had a definite limit on the complexity of the experiments I could do without a proper lab. A proper lab is not necessarily an expensive one, just a well-ordered one. In any event, I started making the gadgets necessary for the streamer work.

The first order of business was to make an RF power supply which could be varied in both frequency and output voltage over a wide range. This turned out to be a simple oscillator using a 4-250 tube powered by a high voltage power supply normally used for electron beam evaporation. The coils were wound on plastic water pipe about 2 1/2 inches in diameter and a range of operating frequencies from 100 kHz through 7 MHz could be covered. Most of the loads seemed to demand a very high impedance so the coils were wound to accommodate this. In the end I could jump a 3/4-inch spark gap in air with most of the coils; this power source for the streamer work turned out to be fairly universal. A pulser, in the form of a grid modulator, was added as an additional feature to help determine the time dependence of the streamers formed.

The Magic of High Atomic Number

A miniature version of the sphere I had seen in San Diego was fabricated from laboratory glass apparatus, and fired up with various gases and pressures. The streamers that I got were pretty good but lacked the fine lace structure of the one in San Diego. The best gas for the effect I was looking for was argon, but it still was not great. At this point I made an effort to get hold of Robert Golka and ask him what the trick was. Golka was driving across the country at that time and was to arrive in Brockton in a few days. After a while I did talk to Golka and arrange for a consulting session with him in Brockton. The salient point of that meeting was that *krypton* was used in the San Diego device and that made all the difference in the world.

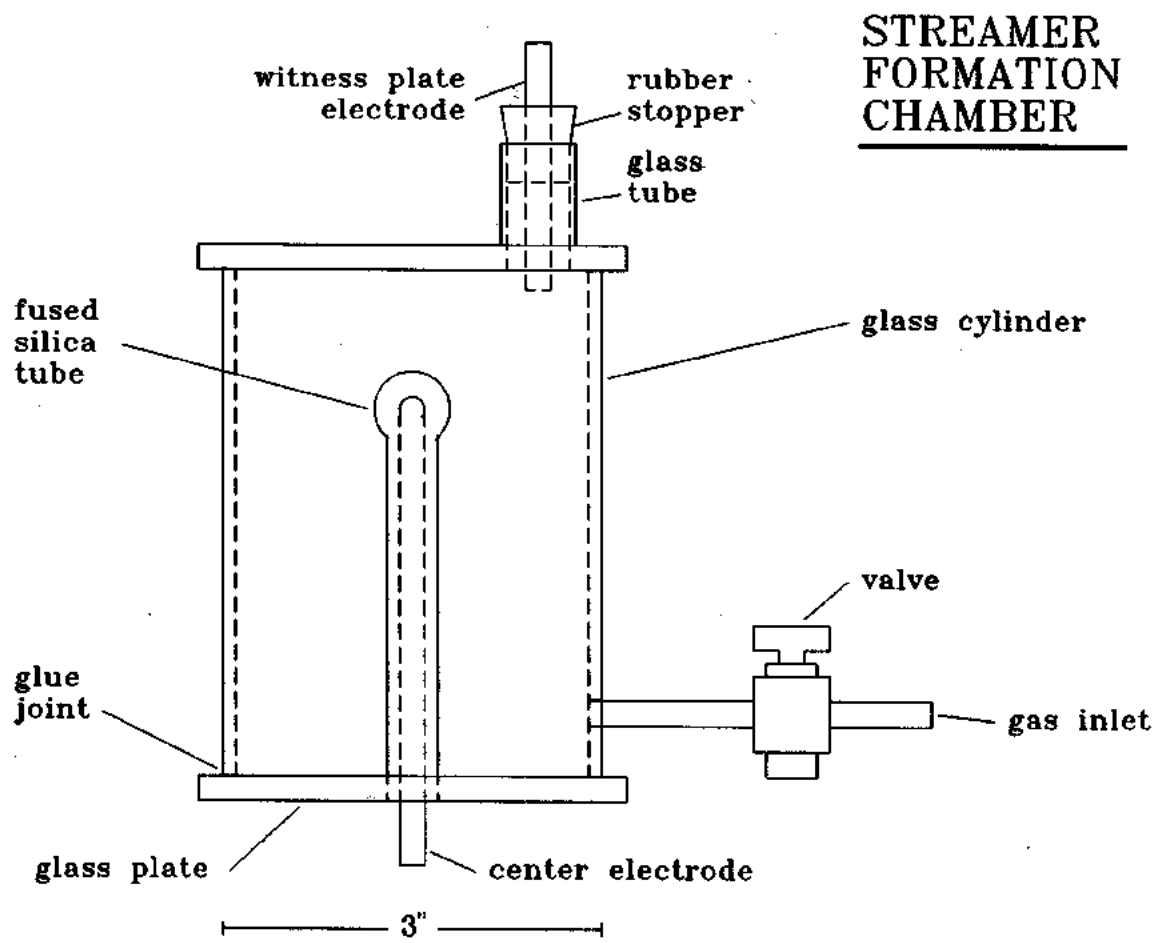

Figure 6:1

I tried krypton in the little experimental setup I had made; it worked fantastically well. In a short time I had gone through all of the parameters available to me with the apparatus I had made. Pressure, gas mixtures, frequencies, and currents were tested and the best operating points for the streamers I wanted to work with were nailed down.

In a short while, a bottle of xenon I had ordered had come in. It was tried with the most delightful results imaginable. The xenon streamers were finer and brighter and they did a wider variety of tricks than the krypton did. It was noted, however, that the xenon results were quickly reduced to trash by a wide variety of contaminating gases. Air, water, and halogens had to be eliminated from the experiment. These electronegative gases apparently gobbled up too many electrons.

A New Glass Jar

I quickly reached the limits of the simple apparatus, made primarily for artistic purposes, and had to fabricate another piece of apparatus to carry out some new tests. A sketch of this apparatus is shown in Figure 6-1. The outside container, a pyrex glass cylinder, had endplates attached to it with epoxy cement. There was also a small glass cylinder cemented on top to hold a witness plate electrode. One technological advance that was necessary, with this otherwise primitive piece of apparatus, was a fused silica tube to isolate the center electrode, because the power loading on the pyrex tube previously used was too great and it would melt. It also proved desirable to put aluminum wool at the end of the center electrode to help distribute the electric field inside the fused silica tube. A glass stopcock was attached to the side with epoxy cement to allow pump down and gas admission.

In operating this apparatus the chamber is first evacuated with a roughing pump. Then the gas mixture to be used is admitted and finally the stopcock is closed. There is only one electrode shown in the sketch because the other electrode is provided by capacity coupling to any objects near the outside of the cylinder or end covers. This variable coupling effect allows a hand to concentrate fields as it moves over the surface, producing some nice control effects.

No Photos

I apologize at this point for the fact that there were no photographs taken of the work that went on during the streamer period. I think the real reason for this omission is that I kept thinking, "This is only the beginning of something that will finally be worth doing." I am fairly often dominated by this kind of thinking in the beginning of a project. If the project is over before it gets complicated, there may be no material to publish.

On the practical side, it is hard to do justice to these beautiful streamers without color photography. Whatever the causes, there are no photos. The effects produced by these streamers are so incredibly beautiful that anyone even partly interested in the field really needs to have his own apparatus to play with!

There are so many effects to be seen in this apparatus that it would take a separate book to describe them. I allude briefly to many of these effects, concentrating on those that bear on the most obvious EV questions. In order to concentrate the data further, I tabulate some of the observations and then give a brief interpretation as to what I believe caused the effect.

List of Effects Seen

1) At a relatively high RF duty factor and gas pressure, above about $1/50$ atmosphere, very fine streamers seem to form near the top and sides of the center electrode, move toward the center and top of the electrode, and knit themselves into a rope of brilliant, blue-white light that then leaves the electrode to rise lazily to the top surface of the container, whereupon it turns with a small radius and spreads out over the glass surface as myriad rivers of light flowing across the top and then down the glass cylinder finally to subdivide themselves into oblivion. My view of what is happening here is that the EVs are created by some yet unknown process, possibly involving secondary emission and electronic ramming, or shock processes, to momentarily increase the electron density or pressure at the fine streamer points, and then unite like they always do but in a fashion greatly attenuated by the ion sheath covering them. The spreading on the surface is due to greater attraction for the surface than for other strands in the large, loosely knit filament. The final subdivision occurs when the field is reduced to a low value.

2) At high pressure and duty factor there are definite convective effects to be seen in the streamers moving in the gas phase.

3) At high power settings and high pressure, the streamer forms into a strong looking rope on the glass surface that writhes about in the chamber wrapping itself about whatever it can in serpentine fashion, but being careful not to complete a full turn.

4) Low pressure produces several small independent streamers from the center electrode which get smaller in diameter and brightness as the pulse width is reduced. Each of these independent streamers move toward the outer cylinder in a direct radial line without uniting. I believe that the diameter of the visible streamer is a reasonable measure of the number of EVs in the streamer. Under the stated production conditions there is not enough time synchronization or spatial coupling between EVs to unite, and so they remain independent.

5) Even at low pressure there is a tendency for the path of a new streamer to follow the path or ionization trail of an old streamer. This effect can persist for up to $1/10$ second between streamer firings.

6) All streamers on the glass walls can be attracted to and guided by a finger placed on the outside of the container. This is just a way to concentrate the electric field.

7) When a well-formed streamer is observed closely, it is seen to be ruptured when a finger or electrode is brought near the streamer path. The sheath, and part of the core, appear to be deflected away from the electrode and the interior of the streamer yields several bright filamentary objects that attack the glass at the electrode point. I believe these filamentary lights are either the ionization trail of individual EVs or a very small number of them.

8) Banding and intense spots of light can be seen in streamers that have been abruptly terminated or disturbed by a gross object. These spots are stationary as long as the impediment is stationary, but move when the object causing the reflected wave is moved. I believe this is just another example of a wave phenomenon that may be similar to the one proposed during the creation cycle.

9) Several RF cycles are required to start the discharge and the higher the amplitude of RF, the shorter the starting time.

10) If the top plate is viewed from the side, so as to optimize the end view image of streamers running on the plate, high intensity flashes can be seen coming from these endviews as they scan by the detector. A scintillating image is seen on a piece of white paper held in the viewing plane. Apparently there is a high-intensity and narrow-angle light emission directly ahead of the streamer that is produced by the EV within it. It is easy for me to believe that the ionization produced by this light beam is responsible for guiding the EV that follows.

11) Most small streamers prefer to run straight on the glass surface, but will abruptly deflect when they encounter a small imperfection on the surface. The imperfection that causes most of the deflection has been found to be dielectric in nature and would make a good miniature mirror for the light beam running ahead of the streamer. This guidance technique can be used to focus individual EV streamer strands into a wide variety of either two- or three-dimensional patterns.

12) When a well developed streamer is attracted with a finger, or other grounded electrode, to a particular place on the container wall, the streamer is terminated there as a disruption into a lot of smaller streamers. The final disruption point is often preceded by a sinuous shape resembling a meander pattern in a river. The stopping action is seen to force a bulge in the main streamer, producing many small streamers laid side by each, extending for a short distance and then reuniting into one streamer again until final dissolution. This behavior is just another example of the coupling action between EVs when their coupling is attenuated by the sheath or streamer.

Witness Plate Tests

With this streamer work, I had set out to show that they were somehow associated with EVs. It just looked like they had to be, judging by their high aspect ratio. The witness plate would be an adequate proof that whatever was in the streamers was also what I had been calling an EV.

A simple test would be to allow the streamer to hit a witness plate and see what was inside. The first test of this was to put a copper grid, with a chromium film on it, on the witness electrode in the apparatus. This was done, but the streamer just sailed past the electrode without seeing it. It was necessary to make the electrode more attractive to the streamer and to break down the protective sheath by adding a small wire to the electrode to increase the capacity. The result of this test has already been shown in the last chapter in Figures 5:10 through 5:13. Without any doubt the streamer contained something very corpuscular in nature.

Not Splattered Material

It is difficult to admit that many of our electron and plasma streams have such charge granularity, and alternative explanations are often sought. One of the handiest explanations is the splattering of material from the cathode (or elsewhere) that somehow makes its way to the target. Never mind the uniformity and apparent low mass of these pieces; they must be the culprit. I have run into that argument often, but the electrodeless discharge used here shoots it down. The electrodes of this system are not eroded and there are no particles thrown from them. The fact is, EVs are somehow formed in the system and the witness plates tell the correct story. We can have lumps in our beams.

No Cathode Spots

Another argument that could be raised against the existence of an EV is that we are really seeing cathode spots, or the formation point for a disruptive discharge. It is not very likely that these discharges would originate on some of the thin-film targets with smooth surfaces, which have a negative radius of curvature. It is also very hard to explain how a cathode spot could be formed on another electrode past our main thin-film target, or how a carbon film could be dented by the formation of a cathode spot. I cannot see how any of the cathode spot arguments hold water. EVs simply exist as an entity of high-charge density and that makes things a lot easier to explain.

Ubiquitous

As I mentioned in Chapter Five, it is not necessary to go to any particular trouble to produce the EV strike mark from a discharge. It is only necessary to allow the spark from some high voltage source, such as a Tesla coil, to hit a metal surface in order to produce the effect. Photos of these effects are shown in Figures 5:7 through 5:9.

I have the impression that history may record our understanding and use of electronics in a way that is similar to our description of fluid dynamics. There will be the time before the discovery of EVs that is equivalent to the laminar flow regime, and then there will be the time after their acceptance that is equivalent to the turbulent regime.

Long and Short EV Sources

Even though there are no photos of the streamer work, there is at least one residual effect that lingers on. The work had taught me to look for electrons that come from some source other than a metallic cathode. This source would be sparse and stingy with electrons. These electrons would have to come from diverse sources such as gas that was recently ionized or secondary electrons generated from the nearby dielectric surfaces. If this were the case, there would have to be a return current, or resupply function, that would allow the sources to recharge at rates of at least thirty megahertz, the highest frequency used up to that time. All common sense rebels at the thought of electrons somehow getting together and forming the thin channels needed to concentrate the electrons to the critical density level required to become an EV. Most ordinary knowledge shows a branching out and scattering of electrons, from a point, during an avalanche process. Of course there are devices designed to prevent this, such as the channel electron multiplier, but there was no such physical process evident on the surface of a streamer EV source. What was going on here?

I had put my time in on devices such as electron multipliers, so I started going over all of the mechanisms I could think of to produce a cascading process for electron production by secondary emission. There is the old Farnsworth RF-type of multiplier, in which two plates with an RF applied to them can multiply, and there is the well-known multipactor process for causing breakdown on dielectric windows in the presence of microwave energy. I had also been privileged to work with a mirror microscope and watch the charge distribution on dielectric surfaces that is nothing like what one would normally think. The patterns of charge move around in raft-like fashion and produce many complex patterns, some of which could be construed to be filamentary in nature. Whatever the truth of the matter, I began to see the possibility of a "long" EV source that got its electrons from a more gradual charge buildup, by electrons hopping on the surface in the presence of the applied fields, and, through secondary emission, slowly reaching the critical level for EV formation. This "long" process is a low-intensity one, and does not greatly task the materials at the source as do the "short" metallic sources that are capable of supplying all of the emission in a short time and in a short physical space.

As I looked further into the question: "Where does one get the electrons for the process of EV formation to begin?" I noticed that the range of gas pressures that best served the formation of streamer-type EVs was such that the electron mean free path was around the magic 20 micrometer range. This is the size range for good channel guidance, the size range for some garden-variety forms of EVs, and incidentally the range of diameters for standard-channel electron multipliers. A lot of things were coming together that could mean a neat EV source, or at least help me explain why gaseous streamer sources did what they did.

With these notions in mind, I was about to bet that gas did not play any fundamental part, and that nearly any resistive dielectric material could be made to satisfy the instantaneous electrons needed to form the EV and furthermore that the resistive component could recharge the depleted surface. The design of a somewhat placid and soft source for EV generation was coming into being. This proposed source looked somewhat less efficient than the metallic ones, but perhaps it would have its place in the systems to come. This sounds very mystical, I am sure, but, as it turns out, things did finally fit together.

Chapter Seven

TRAVELING WAVES

Are They or Aren't They

If there is anything an EV can do, it is travel. In fact, I have never seen one sit still. Indeed, one of the most damning arguments against their very existence as an entity is that they do not seem to exist at rest. They behave like a soliton. I can almost imagine a region of space, charged with energy from the applied potentials, burning like a fuse, with the ignited portion the EV. I cannot answer all of my questions about their behavior with this analogy, but there are enough answers to cause me some uneasiness. Nevertheless, to go on with this business it is necessary to take one view at a time, and for now my view is that somehow they are an entity that I can work with. It is also my view that the only reason I have not seen them at rest is that they must move to generate electrons from their surroundings to feed their unstable state. Perhaps someday I will see a well-fed and undisturbed EV at rest. I sincerely believe a black EV could be gently brought to rest, and still exist as an entity. We shall see.

Self Synchronization

Ever since I first became convinced that EVs were discrete charge entities, it had been on my mind to find a way to circulate them or to guide them in synchronization with a traveling wave. The priority of that work was never high enough to actually begin it until the streamer work made it clear that this would be a quite reasonable task to undertake, because of the absence of dielectric charging effects. I have always thought of an EV traveling on a surface as a kind of self-synchronous phenomenon in which the charge on the surface was depressed by the passage of the EV. This is a form of RC relaxation process, and is not very efficient for high power handling, so I do not count it as a traveling wave effect of any merit, because the recharge time is either too long or has too much loss for practical use. The kind of circuit that was indicated for practical use is the well known LC class of devices such as the helix or coupled resonant-circuit delay line.

Circular vs. Linear Motion

In the beginning of this particular traveling wave work, the aim was to circulate EVs around a diameter of about 15 inches, using an RF drive in the 30 MHz range to supply the circulation losses. In order to learn some of the laws of this domain, I thought it wise to start with a straight section of delay line in order to learn the injection and propagation laws before getting into the circulation problems. This less ambitious approach was also dictated by the fact that the new research laboratory had not been set up and I was constrained to work under conditions that were far from good.

Delay Line

The first order of business was to fabricate a delay line on a glass tubing that would have a delay consistent with measurements using our oscilloscope. Since the scope had a rise time of about 3 ns, it was appropriate to make the delay time at least 16 ns to get away from interfering effects caused by the EV source firing. I wanted the smallest diameter tube that I could get without unduly complicating the attachment of fittings to the end, or making a unit that was so fragile it could not be handled. At this point I was getting most of the actual thing-making on the project done by relatively new and inexperienced people in the laboratory, and this greatly limited the complexity of the technologies available to me.

After a short time a piece of 3 mm outside-diameter glass tubing was wrapped with a coil of wire that gave an impedance of 200 ohms when used as a delay line with capacity loading to ground. Since I did not have a pulse generator with a short enough pulse-rise time to test the delay of the line, I threw together a spark source to generate the necessary pulse. The line gave 16 ns delay for 11 inches of winding on the glass tube. The apparatus used in this experiment is described in more detail in Chapter Eight in the section on *Traveling Waves*.

Length Limitations

I did not have any experience with long path length for EV guides except at high voltage, and the use of high voltage was not thought to be desirable. The compromise length of about one foot for the experiment was deemed to be a reasonable value. Actually, the source characteristics determine the operating voltage more than does the length of gas guide that follows it, but for the next few months we would be locked down to one foot just because we started that way and had some initially good results. Seeing this lock-in effect is usually a warning to me that I am losing my flexibility, but during this period of working with others I had necessarily given up some flexibility.

EVTWT Turnon

On August 13, 1984, the EV Traveling Wave Tube literally flew off the drawing board. In spite of the complexity of all of the interacting elements of EV generation, propagation down a delay line, and catching both the EV and the traveling wave, everything worked the first time around. The experiment literally seemed to turn itself on. This is one of the nicest feelings a designer can have.

Some of the parameters used in this experiment were these:

- 1) The EV source was a mercury-wetted copper wire.
- 2) Xenon gas pressure in the tube was about 3 torr.
- 3) Pulse input voltage was 600 ns width at 1 kv through 1500 ohms.
- 4) EV target voltage was 0 volts.
- 5) Load on the delay line was 200 ohms.
- 6) Load on the target was 50 ohms.
- 7) EV firing rate was 100 pulses per second.

The results of this first run were these:

- 1) Output voltage from the delay line was negative 2 kv.
- 2) Output voltage into the target was negative 60 volts.
- 3) Clear EV strikes could be seen on the target electrode.
- 4) A faint purple glow could be seen in the tube.
- 5) When a positive voltage was applied to the target, visual EV streamers could be seen for the last centimeter of the EV run just before a strike.

Waveforms

The waveform out of the delay line was a function of the gas pressure, as was the length of the tail on the pulse. Basically, the pulse was a sharp negative pulse of about 16 ns in length, followed by a lower amplitude, flat-topped pulse that had a length of virtually zero under ideal conditions. The maximum length of the trailing pulse was linearly related to the gas pressure. The higher the gas pressure, the longer the pulse. The longest pulse I allowed to develop was about one millisecond. It would appear that the length of the pulse was also a measure of the travel time for the EV from the source to the target. From these measurements it can be deduced that the EV lived for a millisecond at high gas pressure because the strike mark could still be clearly seen. During such tests the pulse repetition rate was cut down to just a few pulses per second to allow clearing of ions between pulses.

When the system was working best for high output voltage on the delay line, the gas pressure was minimum. As the pressure was being reduced from some high initial value to the lowest value that would sustain the EV generation, the voltage output on the delay line steadily rose to its maximum value. At the lowest pressure point, there was only the single high-value negative pulse of about 16 ns in width, with no lower amplitude tail on it. This observation of getting maximum output at low gas pressure is consistent with the streamer data obtained earlier, which showed there is an effective shielding action on the EV by the ion sheath around the EV. At the lowest gas pressure, it could be easily measured that the total time delay from EV firing to arrival at the output of the delay line circuit, about one foot away, was equal to $1/10$ the velocity of light. This data is fairly strong evidence that the charge traveling inside the glass tube, along the delay line, was largely composed of electrons and was roughly in synchronization with the wave on the delay line, thus qualifying for legitimate inclusion in the list of traveling wave devices.

Multiple EV Generation

At times it was possible to generate multiple EVs by a process not specifically designed into the system. One of these processes produced two distinct EVs from a slight overshoot of the driving pulse waveform. The ringing time of the pulse generator was 600 ns; an amplitude of only 70 volts produced EVs with the same characteristics as the main EV generation method. This is the trouble with gas systems: they often contribute things that have not been asked for. I liked the low voltage generation process, but it was not really under my control. I suppose the effect arose from a plasma wave or something similar, and since I was eventually going to get rid of the gas there was no use in optimizing the effect.

Statistics

From the preceding data it would seem that we had nearly everything we needed to go ahead with the circulation project. Wrong! What does not show is the way we had to fight and scratch to get back even *part* of the initial results on subsequent tries. I have often heard of something like the "The Law Of The Primary Maximus" which states, "If at first you succeed, you never will again." I sure had a prime example of that law on my hands.

We tried turning things off and then back on again. We changed EV sources. We changed gas pressure and the rise rate of the pressure. We changed turn-on cycles to help clear out any charge that may have remained on the wall from previous runs. We cut pulse length down to 15 ns on the EV driver. We did this not for a day or so, we did this for weeks. At the end of weeks we made new apparatus with different dimensions and went through the same rituals with different incantations.

To give the reader a feeling for the variations encountered, the input and output values would range from the best values shown above to needing 3 or 4 kv to fire off the EV and then getting only 400 volts out of the delay line. Since power in the circuit varied with the square of the voltage, we were being hit by an effect of the first order. The only thing that was consistent was the 60 volts output on the target, but that did not matter since what we wanted was the output from the delay line.

Down in Size

In an effort to get away from some of the geometrically controlled effects, we went down in size with the entire apparatus even though it meant more difficult construction techniques would have to be used. A small ceramic tube with an outside diameter of $1/32$ inch and a length of 4 inches was made and fitted with the same kind of accessories as the larger unit previously described. We also went to a lot of trouble to make a special source, described as an EV Launcher in Chapter Eight. This source set the record of 200 volts for low voltage EV generation and launching in small tubes, but did not get rid of the vagaries in the operation.

In this small apparatus the input pulse was still driven through the 1500 ohm current limiting resistor, but the delay line impedance and load was lowered to 170 ohms. With all of these changes the results went from rotten values such as 1250 volts input with 240 volts output to slightly interesting values of 1 kv input for 450 volts output and 2 kv input with 900 volts output. There was just no greatness to be found around here.

Stress

The characteristic of the variation was what gave me such a bad time. When the particular run worked, it worked pretty well for a reasonable length of time, but eventually something would happen. At times the cathode would shift its operating point and that would end the good results. At times the cathode would not change and something else would happen such as a charge change on the wall, and that would throw the operation off. Of course we coated the inside of the tubes with resistive material, but that was not the trick. We tried all normal variations we could think of within the antique technology that was available to us. None of these things worked.

To say the least, I was highly stressed. I was bent way out of shape by the group effect that forced me to work steadily and not jump around a lot as I am used to doing when I work alone. I do not even like someone to know what I am doing when I work because they might ask what happened to the last thing I was working on. Normally, in the period of a day, the last thing has died and so have several other schemes since the first time I saw the inquisitor. I am willing to bear the onus of behaving in this way because I have found the methods I need to solve problems and break barriers. On the other hand, it is difficult to work these methods into a group action without causing trouble within the group.

An additional stress producer also occurred at this time in our operation. It came in the form of Bill Church suddenly becoming a person acting more like a chief executive officer than the good old Bill, scientific log jam buster, whom I had known for seven years. Perhaps the acquisition of a small tribe triggers off this authoritarian response. This new development set off some waves that really stopped my motion for a long time to come.

Wrap Up

This phase of the TWT work ended without a satisfactory technical conclusion. After more time goes by, we may look back and muse that premature termination was caused by political intrigue or the like. My claim then was that the technologies used were not up to the task. Perhaps some people can bash their heads into the technological wall every day and get the job done, but not me. What happened is that we slowly started ambling down the road to technological improvement by going into film work using thermal evaporation of metals and dielectrics. Photolithography was to be our shape-defining technique and we would move toward smaller structures, the natural realm of the EV.

Looking back on this phase of work from my present vantage point, I can see a host of effects that would produce the spotty results we got. One thing I had failed to consider at the time was that the EV is a known periodic structure, composed of bead chains with a defined spacing between them, determined by parameters in the source and the following purifying train. This periodic structure was interacting intensely with surrounding periodic structures in our apparatus. We were deeply immersed in coherent interactions that are capable of constructive and destructive interference and we had no control over the fundamental parameters of the process, such as bead chain spacing. I am glad I quit fighting traveling waves when I did, even though quitting made me look pretty bad at the time. I should have trusted my intuition and quit sooner instead of dragging out the process.

Chapter Eight

COMPONENTS AND DEVICES

In any discussion about EVs, a question that always comes up is, "What good are they?" meaning, "What kind of gadgets do they make?" Here are a few things I believe about the use of EVs, although at this point the statements may be somewhat speculative. However statements being speculative never deterred me before! In this discussion it is not easy to separate components from more complete devices, so this chapter has a mix of the two.

EV Sources

EV sources are the second most difficult aspect of the entire EV field. The *most* difficult task is knowing what the EV itself is. If we knew exactly what an EV was, we could better accommodate its generation and use, but for the present I must be content to generate them, using the few experimental guidelines that have been developed. I hope that someone else will gain, from this chapter on devices, a little more insight into EV formation mechanisms and EV use.

As stated in Chapter Six, at this point in time there are, in my mind, two broad classes of EV sources. There is the "short" source that is characterized by a violent eruption of material and intense plasma production, or at least intense electron emission from a field emitter, and there is the "long" source that is gentle although probably somewhat less efficient. This long source was first seen in the streamer work where EVs seemed to come to life as microscopic threads on a surface in a gas discharge with RF power sources. Since the short source was known to me first, I will describe it first.

Basic Firing Sequence

I will attempt a basic description of the sequence involved in forming an EV from a short plasma source, but since I do not know just what that really entails, do not expect too much from this explanation. Also, I will not repeat many of the fine descriptions of cathode spot and arc initiation theories available in the literature. For an enlightening discussion of what goes on during the first few picoseconds of an arc's life, I recommend Mesyats [Mesyats, 1982, 1983]. I think his discussion bears heavily on what happens during the early part of the formation cycle of a short EV.

As the electric field is raised at the cathode, liquid metal is drawn up into a sharp Taylor cone and a point is finally reached whereby field emission first occurs and a runaway process commences. This process requires some gas to be present beyond the cathode, or to be vaporized from the cathode by heating the cathode with the emission current passing through the cathode material. The electron emission ionizes this gas, and the charge separation produced enhances the field at the cathode. The process then regenerates, as quickly as thermal and material supply sources allow, until thermionic emission also comes into the process by heating from particle collision and back-bombardment of the cathode by ions. This is a very complex process; it is a wonder that anyone has figured out anything about it, even if it has taken over 80 years.

The Birth of an EV

And then a miracle happens. Somehow, out of this mess an EV emerges. If there was ever an example of how order is created out of chaos, this is it. I have not been privy to the finest details of this birth because it is a deep dark secret, veiled by a high density of particles moving like mad hornets around a despoiled nest. What I have seen, by observing from the outside with an electron camera, is an EV emerging from the plasma cloud.

Some of the observations were discussed in Chapter Four, and shown in Figure 4:1. At first it shines through the cloud just enough to see its outline. At this point it obeys the law of its mother plasma and moves as if it were positive in polarity. When it finally moves beyond the maws of the womb and cleanses itself, it has become an entity obeying the laws of the electron. It is a magnificent birth cycle that can be easily repeated billions upon billions of times. One day I will probe further into this little miracle but for now I must be content to use the offspring in some mundane fashion.

EV SOURCES

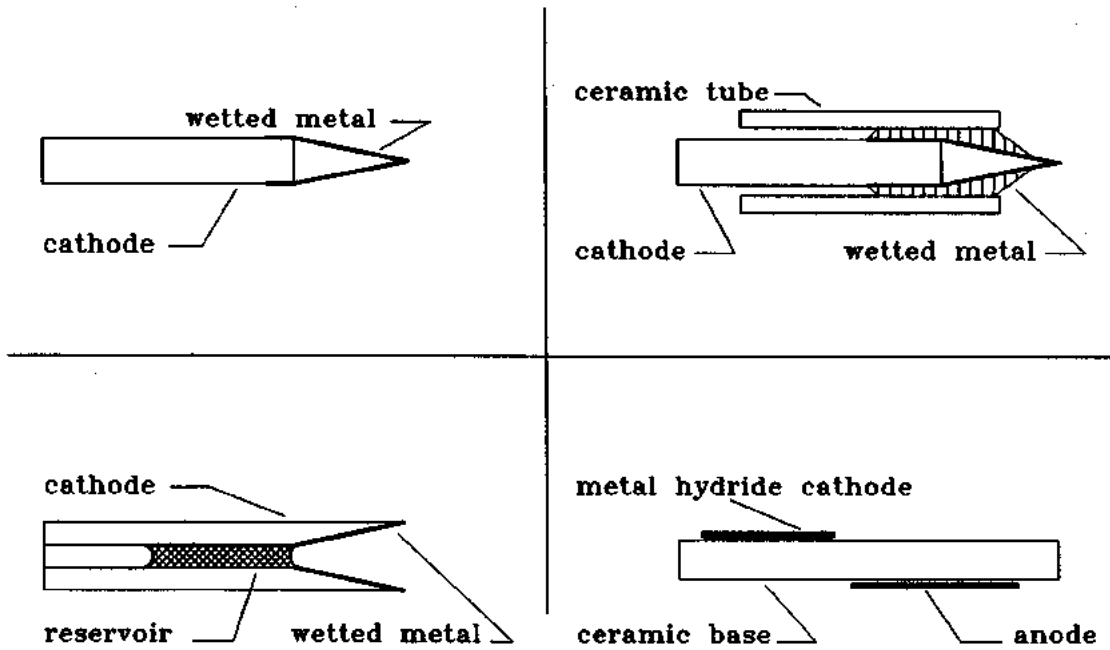

Figure 8:1

Metal Vapor Sources

As a general statement about short sources that can be fired repeatedly, it can be said that a migratory conductor is needed on a conductive substrate that has a field-enhancing shape. As a simple example of this, consider a mercury coating on a sharpened copper wire. Most variations on this basic scheme are just ways to help along slightly deficient properties of material migration, return evaporated material to the source, keep the field-producing structure sharp, or help reduce ionization time to promote faster firing of the source. Figure 8:1 shows some examples of geometries that help accomplish some of the desired results. All of these sources are designed for EV emission from a specific point, but area sources are also possible. Although it is convenient to operate at room temperature, it is not a strict requirement of this type of source. A source operating at around 600 degrees centigrade was made by starting with a carbon cathode, reacting titanium with the carbon and then wetting aluminum to the titanium carbide. This source worked very well but of course there is a huge energy premium to be paid for operating at elevated temperatures

EV SURFACE SOURCE

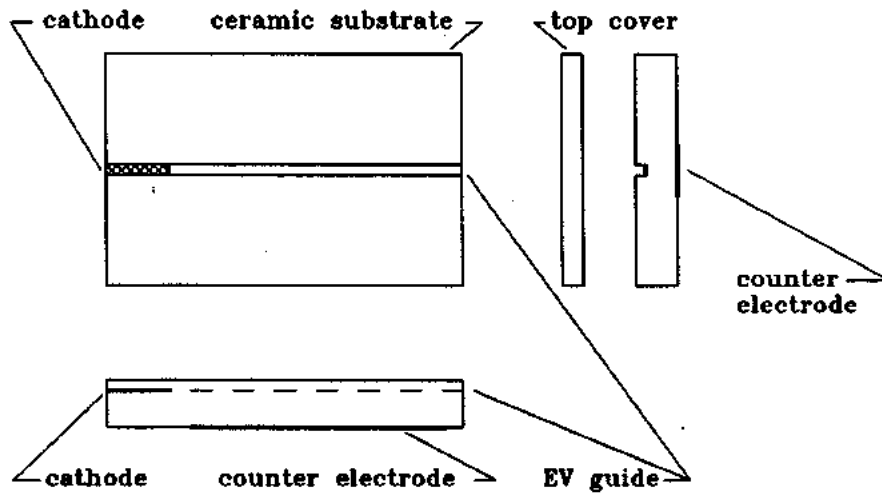

Figure 8:2

Surface Source

EV use often involves guiding them on or near a surface, and this requires coupling them from the source to the surface. In the previous sources described it is possible to locate the source a small distance from a propagating surface and have them work well, but the device described here is inherently coupled to the surface and guide.

The basis for operation of this source stems from the fringing field lines at the edge of the cathode that causes a sharpening effect on the mobile cathode metal used. A drawing of the source is shown in Figure 8:2. A preferred embodiment is to use alumina substrates and aluminum oxide film coverings, doped with tungsten, to make the channels for EV guidance. Evaporated molybdenum has been used as a lead wire material, with mercury added to the molybdenum surface by ion bombardment. Mercury and molybdenum do not have a high solubility; for this reason it is preferable to add an intermediate material, such as nickel, to increase the bonding. Copper and silver are too soluble in mercury for use in a film circuit, as they can be rapidly dissolved away.

A flat coverplate on the channel can be used with this configuration. It is necessary to coat this cover plate with a charge-dispersing material such as doped alumina to prevent channel charging.

EV LAUNCHER

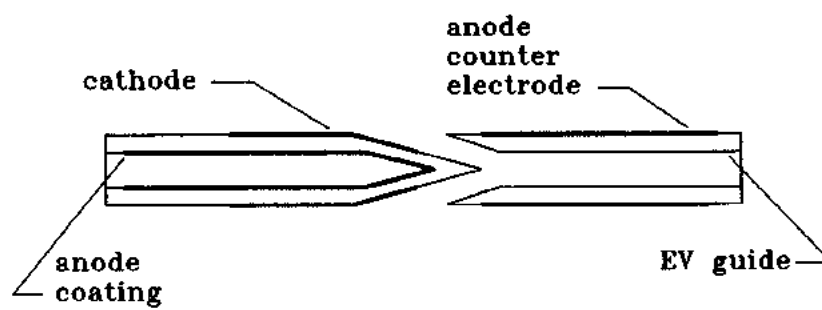

Figure 8:3

EV Launcher

In contrast to the surface source just described, it is sometimes desirable to launch an EV into space or through a gap before it enters the guide region. This can be accomplished with the device shown in Figure 8:3. This configuration uses a liquid metal cathode on the outside of a ceramic body. The ceramic is sharply pointed at the end that is intended for launching an EV. The anode of the EV generator is applied inside the ceramic, with special care being used to carry the anode past the end of the cathode region. In many ways this source is similar to the one previously described in that the mobile metal is drawn to a thin ring at the end of the cathode nearest the anode. Firing can be seen all around the cathode region taking place in a time-sharing fashion. At high pulse-repetition rates there is a steady glow around the cathode end.

The extraction voltage applied to the EV guide is an inherent part of this source and without it the source will not fire correctly. The extraction voltage is normally the ground potential of the system when the cathode is run at some negative voltage. When a wall thickness between the cathode and anode of about 0.003 inches is used with the source shown, an EV can be formed and transferred to the guide when the cathode pulse is as low as 200 volts. A low-pressure gas in the guide is necessary to achieve this operating voltage.

Inorganic Gas Source

As with all attempts to generalize, many effects seem to fall outside the list of general rules. For example, the source shown in the lower right corner of Figure 8:1 does not use a migratory conductor deposited on a field-enhancing conductor. This source also has a shorter life characteristic than the other sources. The titanium hydride is a regenerable metal that the hydrogen can be put back into, but there is no positive return path, or no real flow of material, so after a period of use the active material in the cathode disperses and the source fails to fire.

ELECTRODELESS EV SOURCE

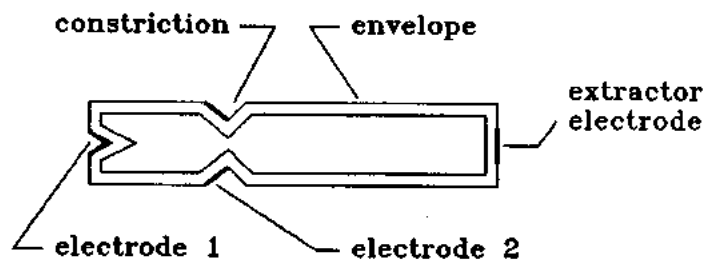

Figure 8:4

Organic Gas Sources

Another example, mentioned in an earlier chapter, that falls outside the strict definition of a short source, would be the nitroglycerin-wetted metal cathode. In this case, the only reason for nitrating the glycerin was to impart some conductivity to the organic material, by including acids, and this was a very artificial means for doing so. The same holds true for sodium-iodide-doped glycerin. As long as the quantity of non-conductive material is kept to very thin layers, it is not necessary to dope for conductivity. Polarization of the material is sufficient to move it in a field, and this can act as a pump to get the material to a field-enhancing tip. As mentioned also in an earlier chapter, the reason for trying organic materials of the nitroglycerin class was to see if a gaseous byproduct of the mobile material could be found. Without going into long life tests, it appears that most of the residue of the organic explosion removes itself from the area of the cathode. In this class of experiment it is necessary to limit the peak energy to prevent cathode damage.

Electrodeless Source

During the work on traveling waves, described in Chapter Seven, there were a lot of variations tried to test the feasibility of using a high pressure source region for the generation of EVs while at the same time using a low pressure in another region where the traveling wave circuit was operated. Figure 8:4 shows one of the structures that gave reasonable performance for this mode of operation. The RF voltage used to generate the EV was applied to the short end of the enclosure and the EV was taken out through the aperture. An aperture as small as $1/1000$ of an inch was used and the EV still went through. The smallest size aperture is desirable from the standpoint of the pumping capacity needed to keep the low pressure section operating properly. This source was made of aluminum oxide and metallized with silver where the electrodes were needed. Although this source produced nice EVs, it was not used in the TWT applications because of the need for constant pumping. For large power applications, where there is no objection to pumping, it is a moderately efficient source. EVs can be generated with as low as a few hundred volts applied.

EV SEPARATORS

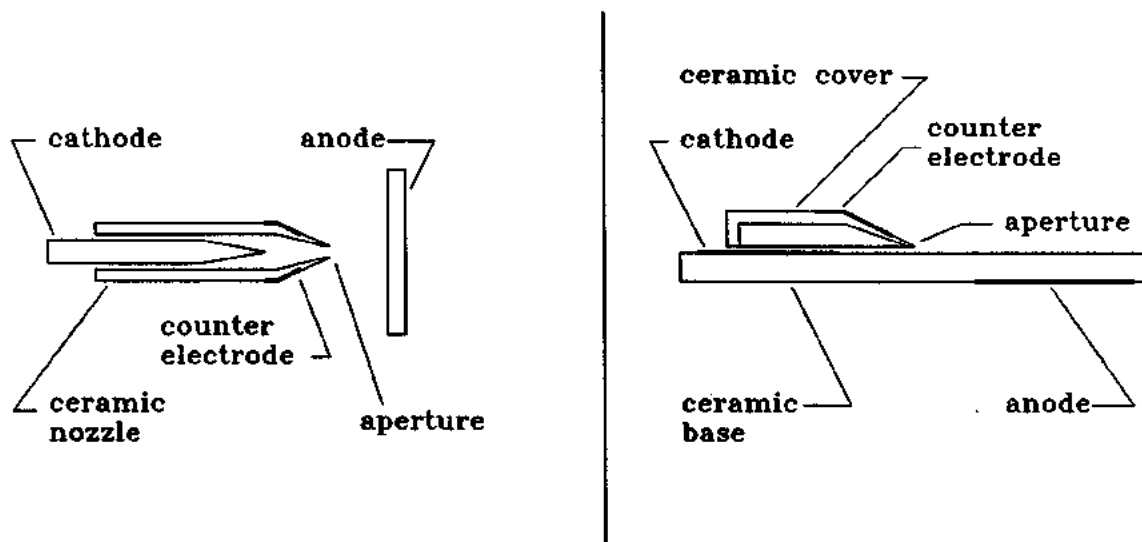

Figure 8:5

Separator

In most plasma work it is not very easy to see the effects of an EV because they are obscured by all of the ions and disorganized electrons. This problem can be greatly reduced by using a cover or "dog house" over the plasma source. The EV can be led out of the enclosure by using a small guide groove or aperture placed somewhere on the way to the anode or extractor electrode. Figure 8:5 shows two versions of this device. The one on the left is essentially a cylindrical ceramic piece with a small hole in one end. This ceramic nozzle contains a cathode, for example, mercury-wetted copper, that created the plasma discharge and hence the EV. A thick film type of separator is shown on the right and this one has typically been an aluminum oxide base with silver fired on it. Mercury is wetted onto the silver.

EV CIRCUIT

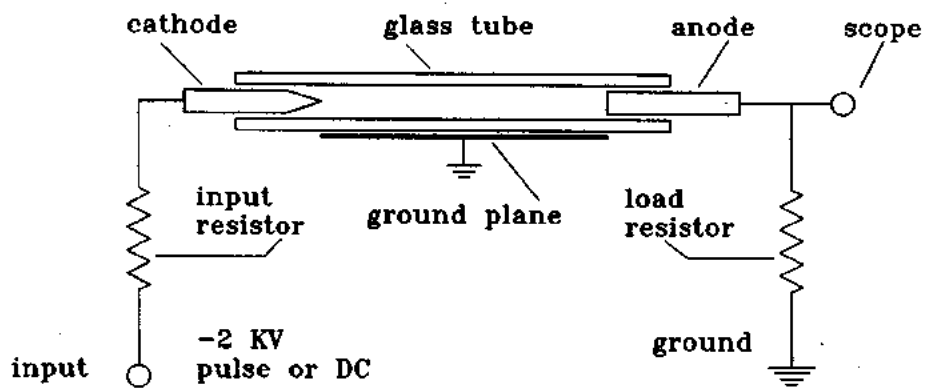

Figure 8:6

Operating Circuit

There are a few general rules I have followed in operating the short sources. I have attempted to limit the peak energy at the cathode to a value just high enough to generate the EV I want. The usual way to do this is to put a current-limiting resistor in the cathode circuit, and place it as close as possible to the EV source. When this resistor can be made an integral part of the EV source by firing the resistor into the ceramic material comprising the source, the results are better for long life. A resistor value of between 500 and 1500 ohms is good for laboratory work. Figure 8:6 is a typical circuit for using an EV source. With direct current or pulse power supplies, it is necessary to complete the current flow path around the loop and this entails using an anode of some type to collect the EV. What is shown in Figure 8:6 is a configuration that requires gas in the glass tube if a long path length is used at low voltage. This is basically the EVTWT device without the delay line wrapped around the glass tube. In other applications the glass tube can be replaced by a guide of another type and various circuits devised to take advantage of the EV properties.

Pulse Duration Effects

A second guideline for firing short sources, one that has not been accurately quantified, applies to liquid metal cathodes where Taylor cone formation is at work; this guideline states that it is necessary to factor in the length of the applied pulse. For direct current and very long pulse applications, the applied voltage is somewhat lower than for very short pulses. Presumably the metal requires a finite time to migrate to the tip of the cathode, and this delay gives rise to the pulse length sensitivity. Even with this delay, pulses as short as 3 ns have been used with mercury-wetted copper sources without raising the voltage more than a factor of two over that of a 600 ns pulse.

Field Emission EV Sources

The field emission EV source is one that definitely falls into the short EV source class, but this source does not have the limitations on lifetime, because of source material dispersal, that the liquid metal ones do. There are special requirements, however, that will limit the utility of this class of sources to complete EV systems having considerable complexity. This was also the case with individual field emission devices used in conventional electronic applications and described by Shoulders [Shoulders, 1961, 1965]. One device cannot be made and put in a can and sold because the energy storage of the leads alone would destroy it when operating voltage was applied.

The principle requirement for generating an EV is to suddenly have a very high uncompensated electronic charge in a small volume of space. This implies an emission process coupled to a fast switching process. In the previously described types of EV generators, the switching process comes from the nonlinear action of gas ionization and perhaps some electronic ram effects. If it is desirable to eliminate all gas and migratory material from the system of EV generation and use, then pure field emission can be used, if a fast switching process is provided and coupled to the field emitter in such a way that emission can be switched on and then off again before the emitter is heated to the evaporation point by electronic conduction.

Picopulser

The field emission EV source just discussed uses field emission operated in an emission density region, beyond the range normally used for other devices, by pulsing the emitter on and off very rapidly. Since the thermal time constant on the emitter is shorter than one picosecond, it is convenient to use EV-driven pulse generators. An example of such a pulse generator made from fairly large components is shown in Figure 8:7. The overall dimension of the picopulser is about 0.2 inches.

PULSE GENERATOR

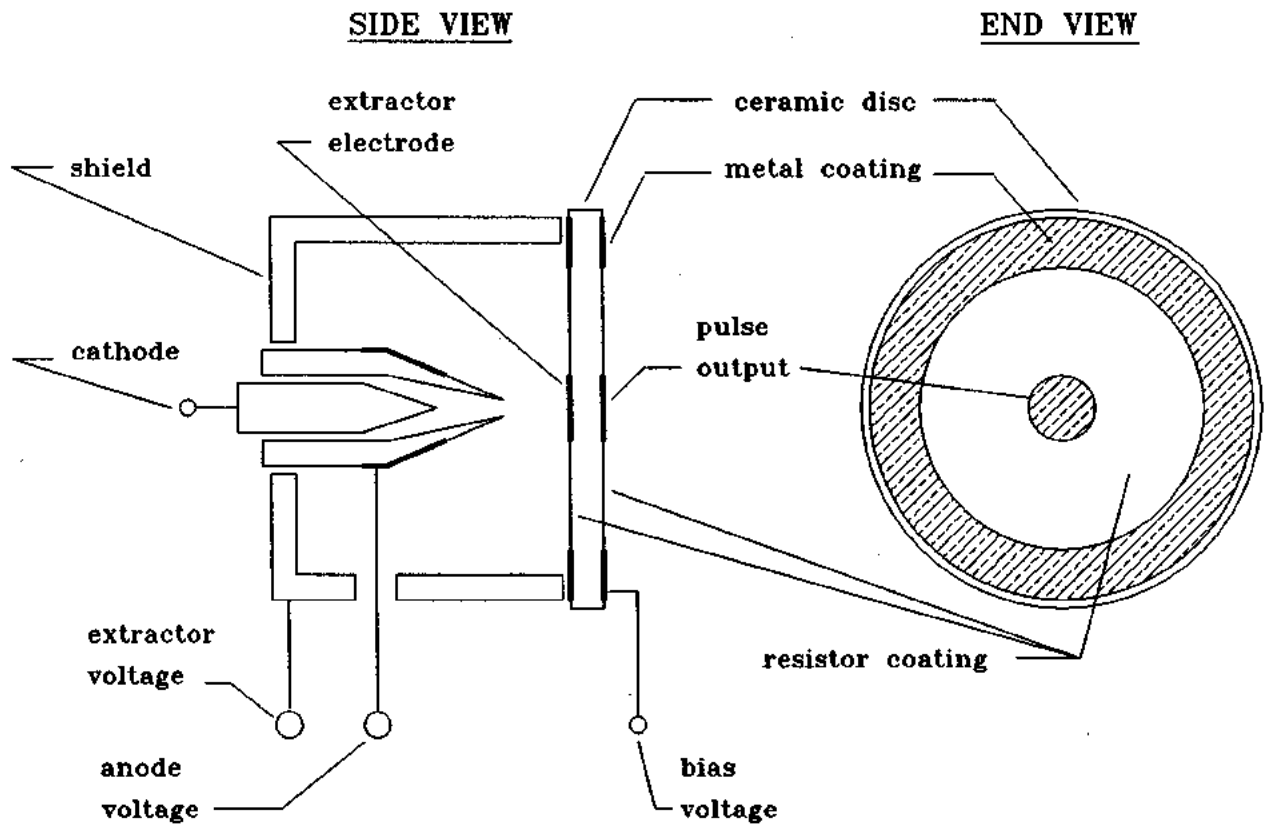

Figure 8:7

FIELD EMISSION EV SOURCE

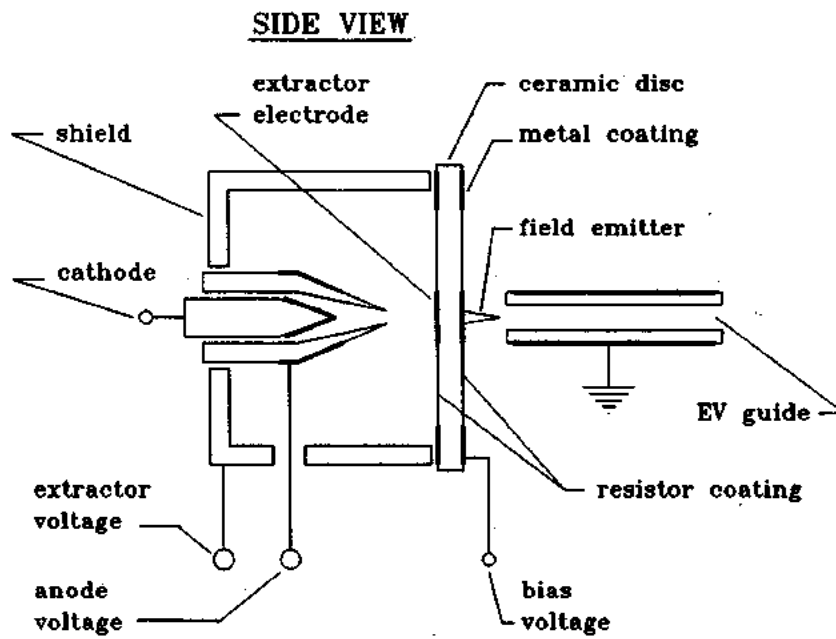

Figure 8:8

An example of the picopulser coupled to a standard field emitter is shown in Figure 8:8. In use, an EV is formed in the cathode region of the enclosed liquid metal generator. The EV is then extracted by applying a positive voltage to the extractor electrode. Upon striking the extractor electrode, a powerful, short pulse is generated and capacity-coupled to the pulse output electrode. This electrode has a bias electrode attached to it, and can be used for setting bias voltage on the field emitter. The resistor coating on the primary EV side of the ceramic disc is about 0.01 ohms and the coating on the field emitter side of the disc is about 1 megohm.

With the electrodes available in this apparatus, many high speed effects can be investigated. If the output from the pulse generator is kept low in voltage, and a sensitive detector used for detecting emission from the field emitter, it is possible to measure effectively very short pulse voltage amplitude by a substitution technique using the high speed rectification ability of the field emitter. Bias voltage is simply substituted for the pulse voltage.

Inquiry into the state of the field emission cathode can also be made with this apparatus by turning off the pulse generator and looking at the emission pattern on a phosphor screen. This is a very versatile piece of apparatus and a lot of measurements can be made in a difficult region of voltage and speed.

At higher levels of pulse voltage, far into what is usually thought of as the space charge saturation region for the field emitter, the emitter generates bunches of electrons that resemble EVs, as detected on a nearby witness plate. Very little work has been done with this class of generator, but on an early and primitive piece of apparatus this type of source produced smaller EVs than has been discussed in the bulk of the work here. These small EVs are potentially very useful for specialized computer-like applications using charge steering.

Film Field Emission EV Sources

Figure 8:9 shows a geometry amenable to film techniques and Figure 8:10 shows a block circuit diagram for operating the film type of EV source. This type of circuit is the first short source introduced here that completely gets away from liquid metal use. In this source the switching process is carried out by feedback on a time scale that is consistent with the thermal processes in the EV generator. It is necessary to switch the emitter on and off in less than one picosecond to prevent cathode destruction. The feedback shown in Figure 8:10 is a generic type of phase inverter, and can be a transmission line or anything that produces a differentiating overshoot with time delay. The main point to be made here is that the speed must be high and the size is, accordingly, small. In a later section in this chapter a pulse source will be described that is based upon using a slot in a counter electrode below a guide to produce short pulses of both positive and negative polarity.

FIELD EMISSION EV SOURCE

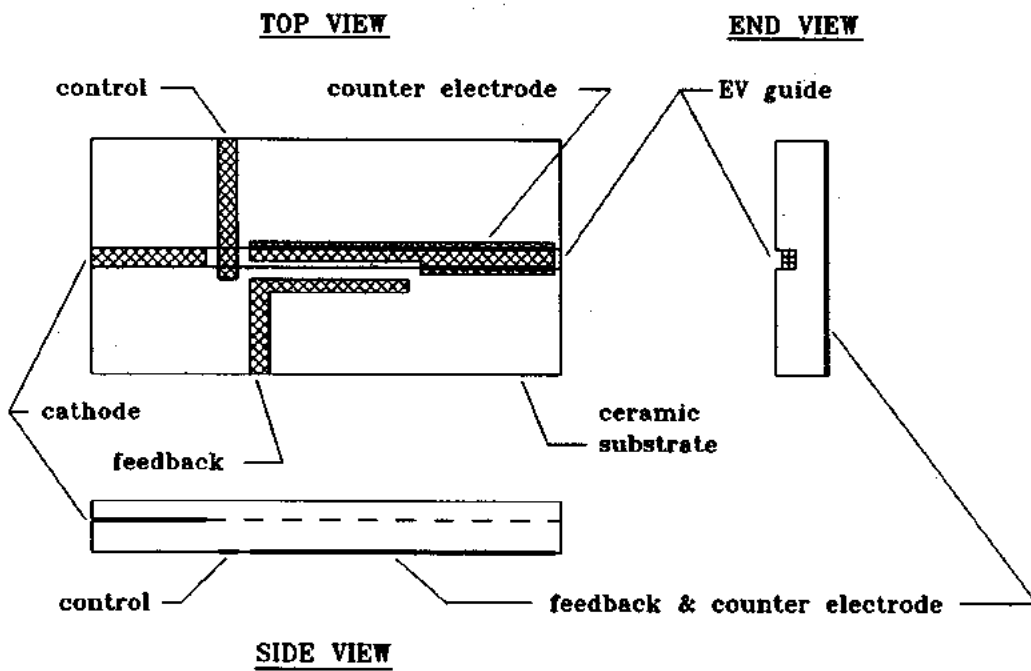

Figure 8:9

FIELD EMISSION EV SOURCE
CIRCUIT DIAGRAM

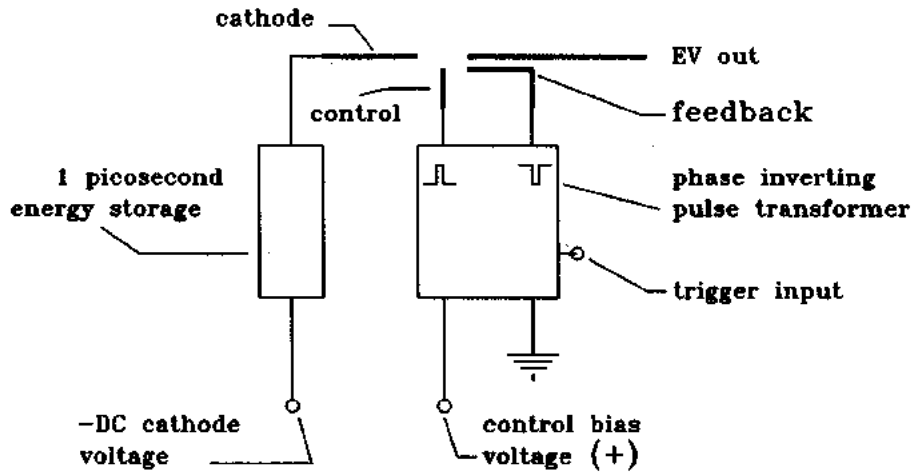

Figure 8:10

Multielectrode EV Sources

As a logical extension of the film sources just shown, Figure 8:11 and Figure 8:12 show multielectrode EV sources based upon field emission that is also free of liquid metal limitations. This type of geometry is used when it is desirable to maintain a fixed cathode and anode potential, while at the same time being able to generate an EV from some other control potential. The EV launcher discussed earlier is a specialized form of multielectrode source, and in any of these applications a triode or tetrode geometry can be used. By analogy to vacuum tubes, a triode is simply a control electrode interposed between the cathode and the anode. As with all control electrodes in any device, there is a degree of interaction between the control input and the output; the tetrode geometry tends to minimize coupling. The sketches shown here are only illustrative of the wide class of devices available, adequately described in the literature for other purposes, and adaptable to EV technology.

Long Sources

There is still a mystery surrounding the detailed mechanisms at work in a long source for producing EVs, although long sources are much more open and available for analysis than the short source. What appears to be happening is that a simple electron multiplication process takes place on a surface, under the stimulation of an applied field. The growth and accumulation of charge finally reaches the level where the containment process, whatever it is, produces the powerful convergence we call the EV. Nothing could be simpler in principle, but there are still many unanswered questions.

The Gas Role

On a flat, secondary electron-producing surface, with an applied field along the length dimension, one would naively expect a cascade of electrons to diverge and show a fanning-out effect because of scatter, surface charge, and space charge. This is evidently not the case with a gas such as xenon available to the surface. The gas is useful, if for no other reason than that it allows one to see, by the ionization of the gas, the path of the electrons in minute detail. Fluorescence of the surface can be seen too, but gas is better. What is seen is that the trails of ions, and presumably electrons, are convergent and not divergent. The process at work here is somewhat obscured by the fact that RF and not direct current is used in this type of open surface test, and the return current ion sheath may play a key role in streamer formation. An interesting observation made with gas is that the pressure range used for optimum formation of an EV is also the pressure where the mean free path of an electron is about the diameter of a bead chain--20 microns. Higher or lower pressures can be used, but this is approximately the center of the useful range.

MULTI-ELECTRODE EV SOURCE

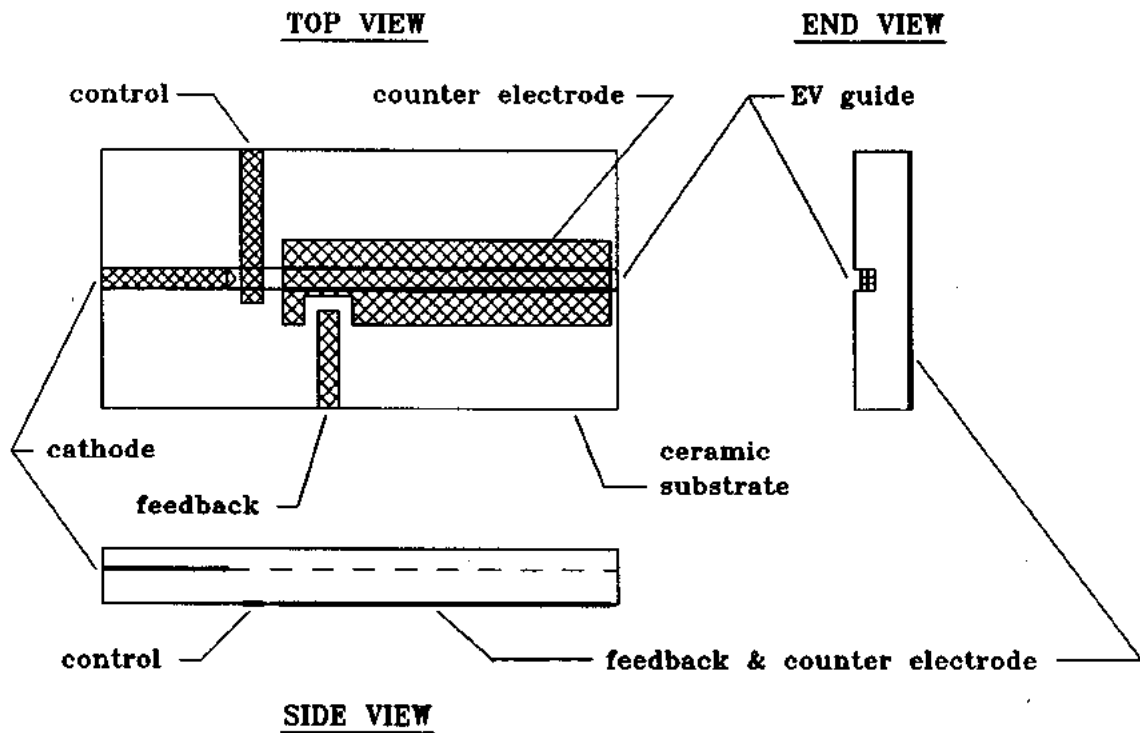

Figure 8:11

MULTI-ELECTRODE EV SOURCE

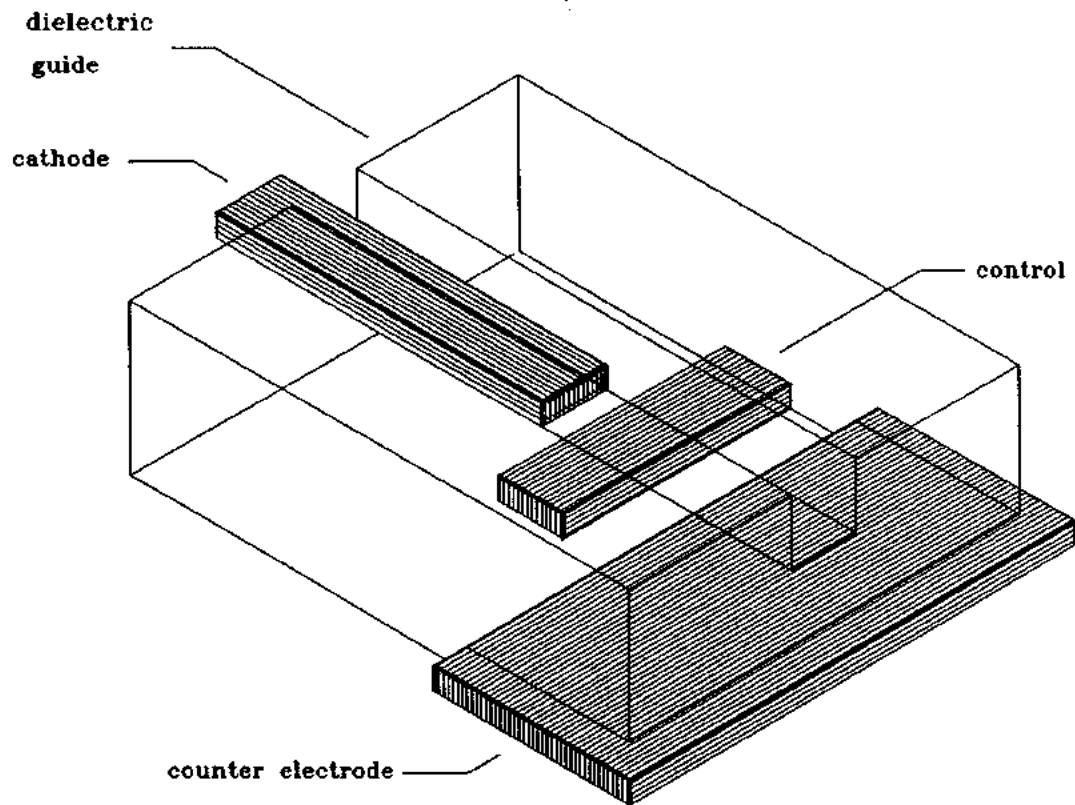

Figure 8:12

Channels

An EV can be formed by raising the electron density of a region of space to the critical EV formation level through the use of secondary emission from nearby surfaces, and perhaps, accompanying electron ram effects. A closed channel shape of dielectric material, for electron containment, coated with a resistance material to distribute potential and provide a field gradient for electrons is the main element for this type of EV generator. It is necessary to have sufficient energy storage in the channel, usually in the form of distributed capacity to a fixed potential electrode, to supply the peak current demanded by the formation process; otherwise, saturation sets in and no EV generation will occur. It is thought that some switching process is also required to steepen the gradient of electron density in the channel. This could be provided by electronic ramming or wave action.

Standard channel electron multipliers can supply some of the functions needed for EV formation, but not all. A problem with standard channel multipliers is that they are usually made from soft glass that will not withstand the energy density of the EV creation and propagation process. Tungsten-doped aluminum oxide is a suitably refractory material for EV formation and use. Presumably there are many other materials with the required properties.

One limitation of the channel EV source stems from the need to have a field along the channel that can be rapidly regenerated after the firing of an EV. This charge regeneration is usually provided by a resistor chain, in some form or other, connected to a power supply. The quiescent power drain due to the resistor is quite high when the resistor value is low enough for high EV formation rate; thus heating of a large system can be severe. The basic problem with this process is that the efficiency of electron production is small for secondary emission--about 100 volts per electron. There is an additional problem with efficiency in that the power distribution system is far from ideal--using resistors for distribution. Direct supply of power from essentially fixed potentials to lumped electrodes would alleviate this problem but would result in increased technological cost. There are other EV sources that are more efficient than the channel type, but the channel generator retains a degree of simplicity that recommends it for certain applications.

There is no prohibition against using gas in a channel to help increase the efficiency of electron generation and to remove the charge from the walls. By using gas, a higher value of channel resistance can be used. In the limit, it is possible to use a pure dielectric and this is the case for EV production in the streamer mode on an open surface. If other system parameters allow the use of gas then there may be some advantage in doing so.

EV GUIDES

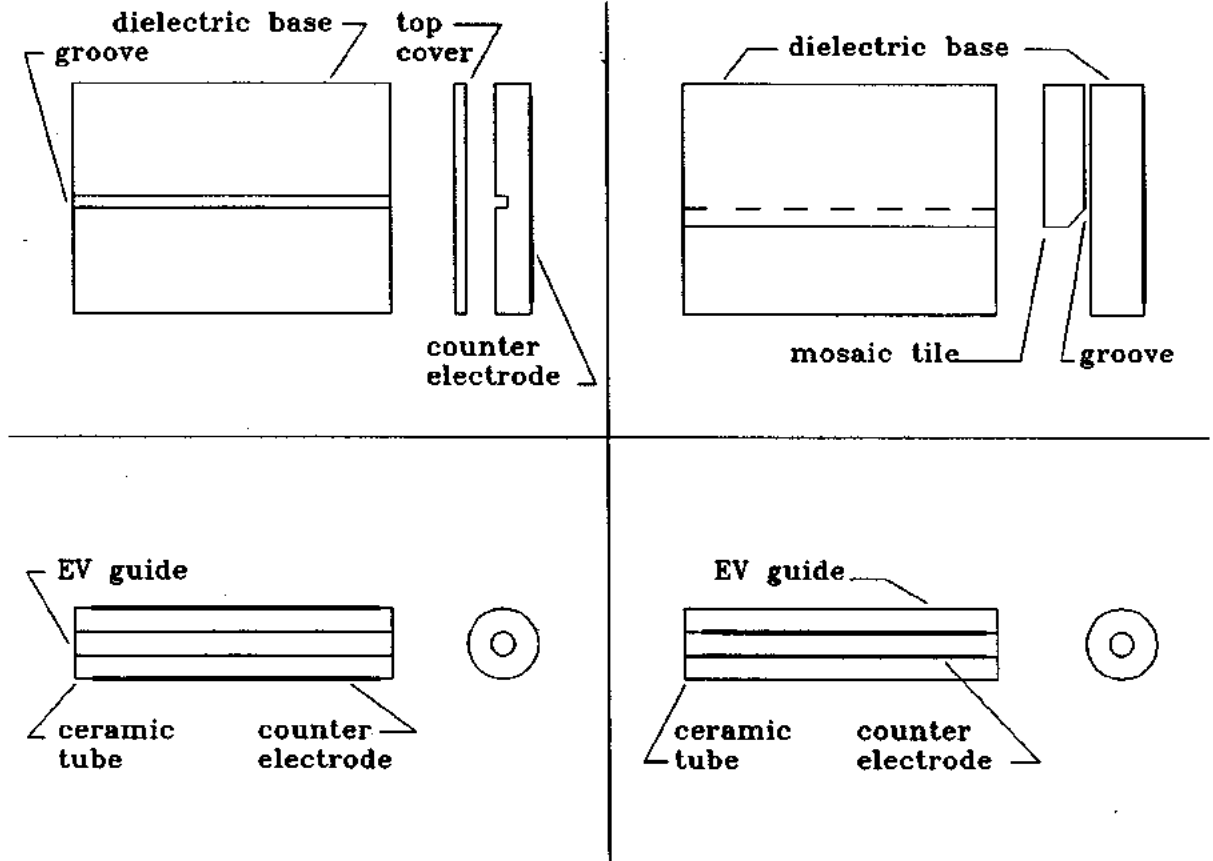

Figure 8:13

Triggers

In all channel sources there is a need to trigger on the process of EV formation by application of a voltage. Although the entire channel can be pulsed, this is not energetically desirable in most applications. A thermionic electron source can be gated on at a low level in the electron multiplier chain without using more than a few volts of gate voltage. A gas discharge can be used, if trigger jitter and low speed can be tolerated. A gated electrode in the secondary emission chain can be used if the input to the chain is fed with a radioactive, thermionic, or field emission source. Photon switching can be provided by illumination of the input to the secondary emission channel. There are many ways of switching on a channel EV source but each application requires a specific trigger process compatible with the rest of the system.

EV Guides

An EV guide is as important as the source otherwise there would be no way to use the EV. As shown in Chapter Five (EV Targets), the guide channels can be highly loaded and a design error can be fatal to the guide. At this point in EV technology, I can see two broad classes of guides and these can be fitted into well-defined engineering terms. The simplest class is the RC guide using doped dielectrics to help control stray charge, and the LC guide that physically resembles delay line structures. Here there is no need for dielectric material in the immediate vicinity of the EV because the distributed LC components act both as stabilizing elements for EV guidance and as stray charge collectors. This latter type of guide is most desirable, but it is more difficult to construct.

RC Guides

There is no long treatment of RC guides in this chapter since enough has been said about them in previous chapters. They are not hard to understand in engineering terms, even though they may be very difficult to understand in a fundamental scientific sense. Figure 8:13 shows an assortment of guide configurations for running EVs on either the outside or inside of dielectric surfaces. One precautionary statement about RC guides--I would expect much more severe breakdown of these simple guides as the concentration of EVs increase in the guides. It may well be that the effectively short pulse time imposed on the dielectric as the EV passes a point is all that saves the dielectric. If a guide were full of EVs, and therefore full of charge, it may not be possible for this class of guide to withstand the charge, and breakdown may occur.

QUADRUPOLE
LC EV GUIDE

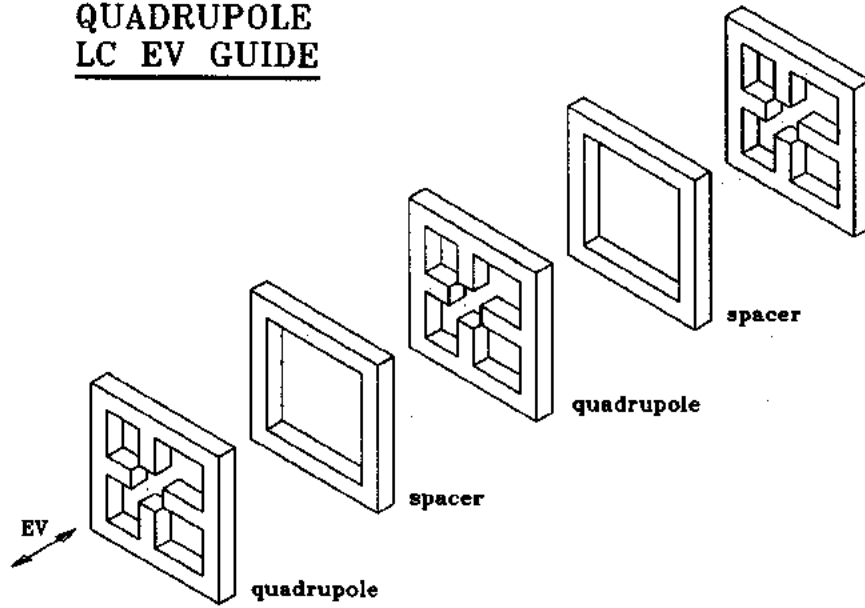

Figure 8:14

An effect, having to do with guide charging, that I do not understand deserves a short mention here. It is obvious when there is a charge on a guide, because a new EV will not enter the charged region. On the other hand, it is known that an EV is actually a train of several charged entities; one might wonder why the second entity in the train does not violently resist following the first one. Perhaps it is because they are linked with a considerable binding energy, thus allowing one EV to follow another if they are not too far separated. The only mechanism I can see at work here is that the space charge of the EV prohibits charging of the channel or surface in the immediate vicinity of the EV, but allows charging at a distance where the scattered electrons can come back to the surface.

LC Guides

Very little has been done about this class of guides but they hold the greatest hope for future development. Although most of the discussion here centers upon small guides that are properly sized for the small EV structures we now work with, there is no reason to limit the upper size of the LC guides when large, high powered applications are concerned and a different construction technology is required. The point to remember about LC guides is that an EV will depress the potential upon any circuit element as it approaches. Inductive elements are most susceptible to this effect. The depressed potential makes the electrode less attractive to the EV, and a steering action is available if there is a more desirable direction to go, as indicated by a higher positive potential elsewhere. Consider the case of an EV entering normal to a quadrupole structure, such as the one shown in Figure 8:14, that has sufficient inductance in each of the four directions to allow a potential depression of the electrodes as the EV approaches. If a single element of this structure is kept short in length, in the direction the EV is going, then there will be a restoring force to the center if the EV deviates from the center position. Having a long array of these quadrupole guidance elements will thus perform the function of an LC guide.

In practice this structure resembles an ordinary delay line in each of the 4 axes, or however many are used. Depending upon the time constant of the LC circuit, there will be a rebound of the potential after the EV passes and eventually the oscillations will subside. This description is greatly simplified for a single EV passage; far more actually goes on in practical circuits. The main point of this discussion is that the dielectric is not needed in a structure that is capable of producing image-like forces for correcting the position of the EV. Both the quadrupole element and the spacer shown in Figure 8:14 are conductors. A stack of these elements can be made in almost any shape as long as the proper timing function is performed.

In the guide just discussed there is a need to consider coupling coefficients between the EV and the guidance structure. There are limits in size for the structure once a particular amount of charge, and hence EV size, is assigned. Too large a structure will not respond adequately for control of the EV, and too small a structure will not allow adequate turning time and space for the EV. Both mistakes in size will result in unstable modes for propagation and therefore destruction of both EV and guide.

LC EV GUIDE

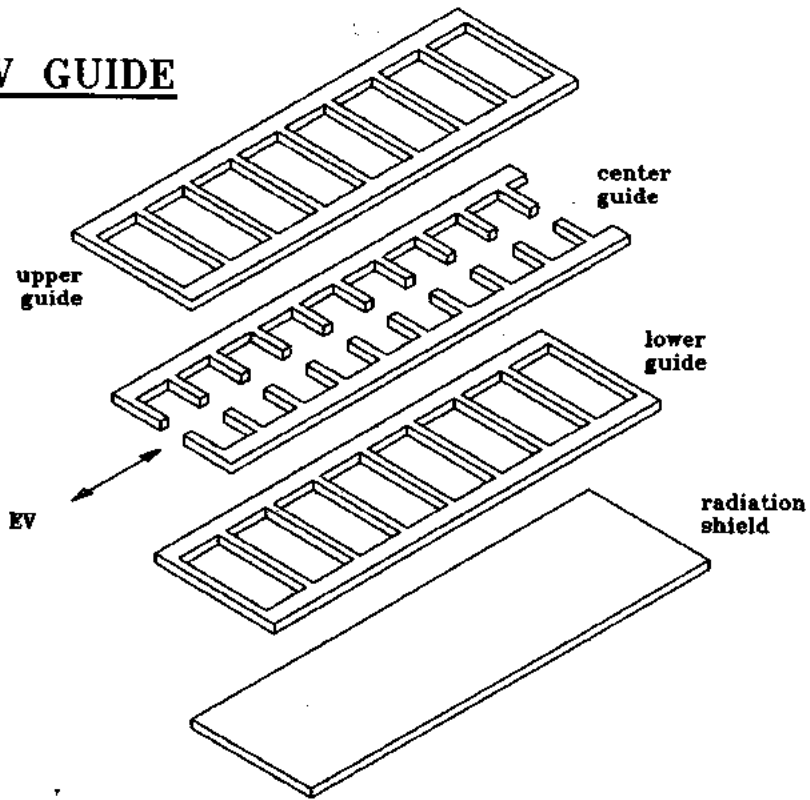

Figure 8:15

An interesting rule of thumb for guide design is that the electrodes designed to couple to the EV can be considered $1/4$ wave structures at the approach frequency of the EV. This frequency is determined primarily by the velocity of the EV and the distance between the EV and the steering elements. Since the diameter of the guide is related to the coupling coefficient, there is an inter-relationship between the diameter of the guide and the spacing of the elements. In this type of guide the $1/4$ wave elements can be operated at direct current or a fixed potential without charging effects. The penalty to pay for this LC guide is that the velocity range for propagation is not arbitrarily wide.

Scaling Considerations

It should be clear that as the number of EVs in a guide increase, so will the power level. I do not yet know what the limit of power handling ability will be, but certainly both the metal and the dielectric get a good working out at submillimeter wavelengths for the size of guides used for our present EVs. An EV requiring an RC guide size of 20 microns would require an LC guide slightly larger. The implied spacing between guidance electrodes would also be in the vicinity of 20 microns. Obviously this is not a very high-power handling structure, and, although parallel units could be used, it seems more economical of material use and processing to scale up the EV to fit larger guides. This scaling is primarily a function of the EV generator or the charge combining circuits following the generators.

Film LC Guides

There are many geometric and electric variations on the guide just discussed, but that type is primarily suited to large structures made by lamination techniques. Different construction techniques are applicable to small structures and particularly to those amenable to film processes. One geometry that fits the basic needs for film construction to confine the EV is shown in Figure 8:15. In this expanded drawing the sideways confinement is obtained by conductive stubs resembling $1/4$ wavelength lines. The top and bottom confinement is accomplished by a similar geometry but this time it is possible to continue through the center and the structure resembles a shorted $1/2$ wavelength line. The entire structure finally becomes a form of slotted waveguide or delay structure. Since the structure is very active electrically and would radiate strongly in the form shown, it is necessary to enclose the structure with conductive planes on both top and bottom to suppress radiation. Again, there is no fundamental need for a potential difference between the various electrodes, and they can be connected together at the edge.

EV Synchronizer

As mentioned in Chapter Seven on traveling wave effects, the EV burst that is generated by most sources is not highly regulated with regard to spacing of the charge entities. There are a variety of processes in the sources that produce the spacing we get, but these processes have been more accidental than intentional. The LC guide structure just discussed is a form of synchronizer that does two things. The mean velocity of the chain is locked to the frequency of the guide, and the spacing of the individual charge entities is forced to fall into synchronization with the slot period of the guide. The effect we wish to secure here is caused by the periodic electric field produced in the guide and the ability of this field to bunch the EV train into that field by accelerating the slow EVs and retarding the fast EVs.

If a guide is initially unoccupied by an EV train, then there is a short time period in which the RF level is too low for strong synchronization. As the RF level builds up, the synchronizing action becomes more effective. The "Q" or figure of merit of the cavity determines the rate of buildup and decay. Too large a Q will cause breakdown of the cavity and this must be avoided. There is an implied optimum filling factor for this synchronizer. With low filling the synchronization is not effective and with a high filling factor there is danger of breakdown and interference with the guide function. A proper synchronizer would be more loosely coupled to the EV than the guide structures shown in Figure 8:14 and 8:15. This loose coupling can be accomplished by using a slotted cavity with small slots on one side of the guide. Using this method the guide would operate at a lower frequency than the synchronizer and have a much broader passband.

RF Generators

Although I have discussed circuits that produce RF in the last two sections the action was associated with internal functions and not used for external radiation. With only slight modification the RF generated can be coupled out of the EV guide and used for whatever purpose is desired. The lower part of Figure 8:16 shows a generic type of RF generator in which a series of slots placed in the counter electrode of the guide provide openings for the charge of the EV to couple out to another electrode that is, in turn, coupled to the radiating system for the RF. In this type of generator there is a reciprocal relationship between the EV velocity and the output cavity that determines the frequency of the radiation. The EV velocity must be in approximate synchronization with the RF frequency before the cavity can lock the EV and show this reciprocal effect. This system shows many of the same effects found in conventional RF generators such as voltage and load effects on frequency. All of the usual harmonic effects also show up in this class of generator.

GATED ELECTRON AND RF SOURCE

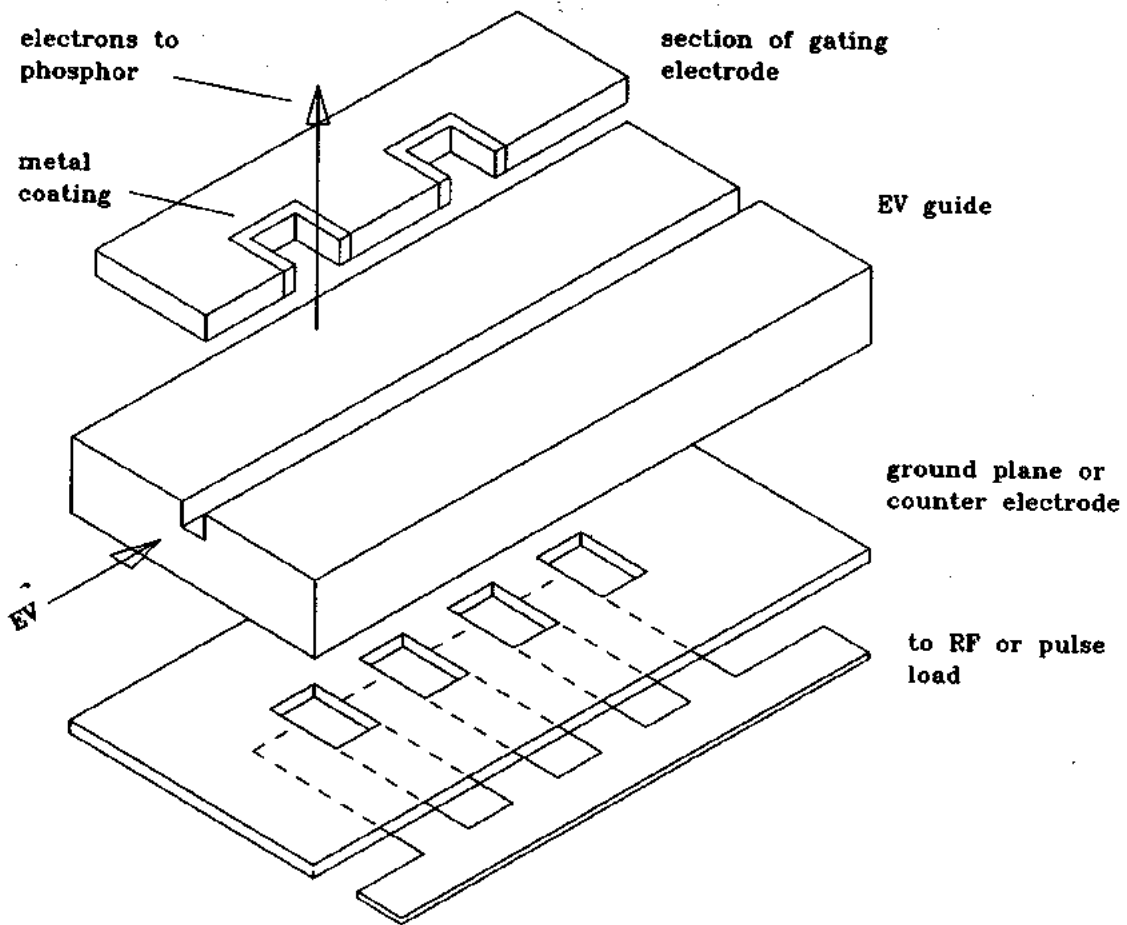

Figure 8:16

Aperiodic Waveforms

Aperiodic waveforms for driving various computer or timing functions can be generated with the structure shown in Figure 8:16 by having openings in the counter electrodes that are shaped like the waveforms to be produced. The load on the output electrode must be proportioned according to the bandwidth of the generated waveform. If low frequencies are expected then the output should be connected to a transmission line with resistive termination at its characteristic impedance. The EV velocity can be locked into synchronous motion by using RF injection or interaction as previously discussed. This helps regulate the periodic rate of the output pulses obtained on the output electrode. With this structure it is possible to generate output pulses of either positive or negative polarity by differentiation of the charge as it passes the slot in the counter electrode. A matched or low load on the output produces essentially negative pulses while a highly loaded output produces first a negative pulse and then a positive one. This effect is beneficial for generating positive waveforms used in driving field emission devices into the emitting state.

Direct Current Output Devices

Direct coupling between the EV and a collector electrode can be obtained in a variety of ways. In using the simple RC guides it is possible to collect electron emission out the top of the guide if the guide is sufficiently deep and the EV is strongly locked to the bottom of the guide or the counter electrode side. The electrons collected on output electrodes come from secondary and field emission sources that have been produced by the energy of the EV. Since these electrons have come from a dielectric material with long RC time constants for recharge, it is necessary to wait for recharge until another EV can occupy the region. In the LC class of guide this time delay is very short since recharge is supplied via metallic electrodes. Electrons can be collected for direct current output service by simply supplying a collector electrode since they have been given initial energy by the EV. This collection can be done by using any of the surrounding electrodes shown in Figure 8:14 or Figure 8:15.

Using Electron Emission

Since it has been found that an EV can be made to emit a fairly narrow band of electron energies when properly stimulated, there is a wide class of devices available for application using the EV as a special type of cathode. The primary consideration in using this cathode is determining the mean energy and the energy spread of the emitted electrons. There is also a gating or chopping effect that comes from having a definite spacing between EVs. The range available goes from essentially steady emission (from a train of circulating EVs) to a very pulse-like emission from passing a single EV under an aperture.

Figure 8:16 shows a cross section of a triode tube-like structure mounted on top of an EV guide and using the EV as the cathode for the triode. The anode is assumed to be the

EV SELECTORS

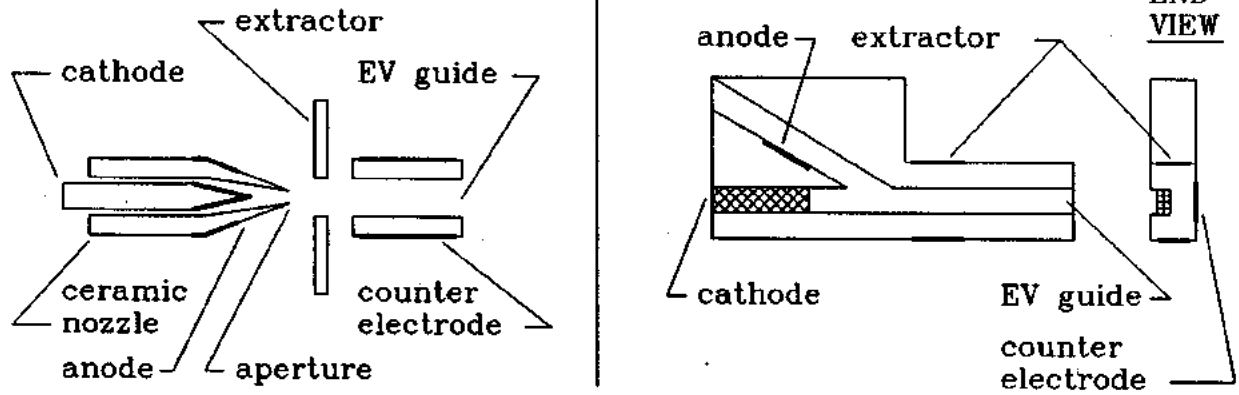

Figure 8:17

phosphor screen or another electrode. In actual practice this type of device would be used in large arrays to achieve some complex function, and the triode would be only one type of the many components in the array. It would hardly be worthwhile to put only one of these things in a can. Since the entire vacuum tube art precedes this device, it is not necessary to go into the subject any further here except to point out that many devices have been bypassed in the past due to insufficient cathode brightness. The EV overcomes this objection, thus opening the door to an even wider class of devices than was available with space-charge-limited thermionic emission. The most noteworthy class bypassed was the beam deflection, free electron device. These can now be reconsidered.

Display Device

One fairly simple use for direct current emission from an EV is the activation of phosphors for light production. This effect can be seen anytime an EV passes by any material that will fluoresce or phosphoresce. If the triode structure mentioned above, or any other control geometry for the emission, is interposed between the EV and a phosphor, a type of cathode ray tube can be produced in which selection of the lighted area is done by gating instead of by sweeping a beam. A large number of active gates and their driving circuitry, obtained by using free electron control circuits, could be formed into large area, flat panel displays. The technology for doing this would consist primarily of lithographically-formed dielectric plates, with metallized holes in them at appropriate places, aligned with EV guides on other plates.

There is no high technology requirement for producing this display device, because neither an EV nor free electron control requires very high technology. In this display application of EVs it is possible to lower the technology requirement of other components normally requiring high technology by judiciously mixing in some EVs. A case in point is that of using field emission, driven by short EV-formed pulses. The short pulse prevents thermal runaway of the emitter, allows operation in the more geometry-tolerant space-charge-limited region, and prevents ion bombardment of the sensitive field-emission cathode.

EV Selector

Simple EV sources generate groups of EVs having various numbers of beads in a chain and various numbers of chains. When it is desirable to have only one particular type of EV to use in a process, then a selector action can help to limit the number of types available and to provide the desired species. The selector action shown here generates a variety of EVs, runs them to an anode or collector on a dielectric surface around a sharp edge, and detaches selected EVs at this edge and then extracts them to a guide surface or other useful region. A drawing of a structure to accomplish this operation is shown in Figure 8:17. The selection process is probably accomplished in a fashion analogous to field emission of electrons.

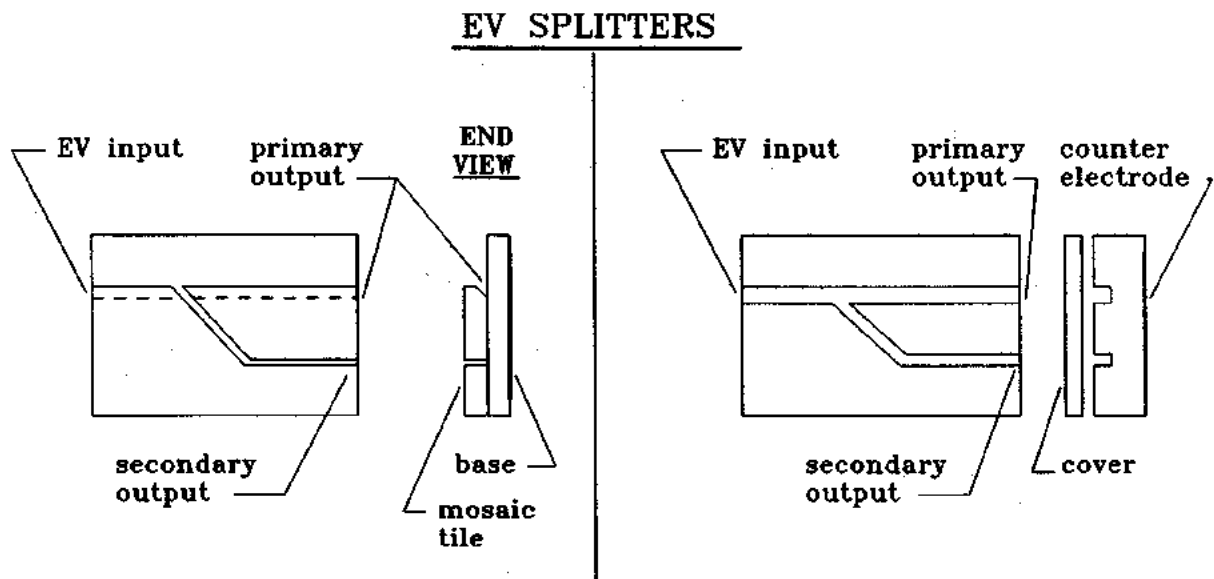

Figure 8:18

I can imagine an action that binds the EV to a dielectric surface, or any other type of guide, but since all such processes have limits of binding strength, it is possible to remove the EV by applying a more attractive situation elsewhere. The application of an external field does the job in this case. The whole game is to limit the binding energy of the EV and then supply someplace to go that is more interesting. By supplying strippers or selectors in a cascade, it is possible to pick one particular binding energy out of a wide range. This process gets particularly sharp when the EV is first destabilized by a resonance process having to do with the desired end effect. In some ways this selection is analogous to atomic excitation and selection because there are many modes to choose from.

EV Splitter

For certain applications involving very close timing or synchronization of events, it is necessary to derive two or more signals from a single input. One method of doing this is to divide the main (or first) event into a multiplicity of subevents. With an EV source that produces a large number of beads or bead-chains within a short period of time, it is possible to divide this temporal event by the process described here. Structures for doing this are shown in Figure 8:18. The principle difference between the two drawings is that one uses the mosaic technique where an EV is locked into an acute angle formed between two surfaces, and the other uses more standard channels or guide grooves.

The EV splitter described here is an experimentally-verified device but, like so many EV devices, things happen too quickly for the details of operation to be known. I can only speculate that the overall action is caused by a type of self-switching between bead-chains as they pass the alternate path in the guide structure. This could be due to a charging process. What is known is that the arrival of EVs at the two outputs has no more jitter between the two than there is between individual bead-chains on a single path. The jitter is almost impossible to measure on the picoscope or electron camera, and this puts it in a time range of substantially less than 10^{-13} seconds.

Deflection Switch

An EV, essentially a negatively charged entity, can be deflected by another charged object if the charge is sufficient in magnitude and applied for a long enough time. The deflection of an EV through whatever guide structure is used is an essential element in EV technology. Obviously there is a bilateral effect at work, and the deflector may experience an unwanted reaction from the EV passage. For optimum switching sensitivity, it is necessary to prepare the EV for deflection by making a marginally stable path preceding the deflection process. In general, this increased sensitivity can be achieved by passing the EV from its tightly bound state in a guide to a region having very little lateral guidance. In this low-stability

EV DEFLECTION SWITCH

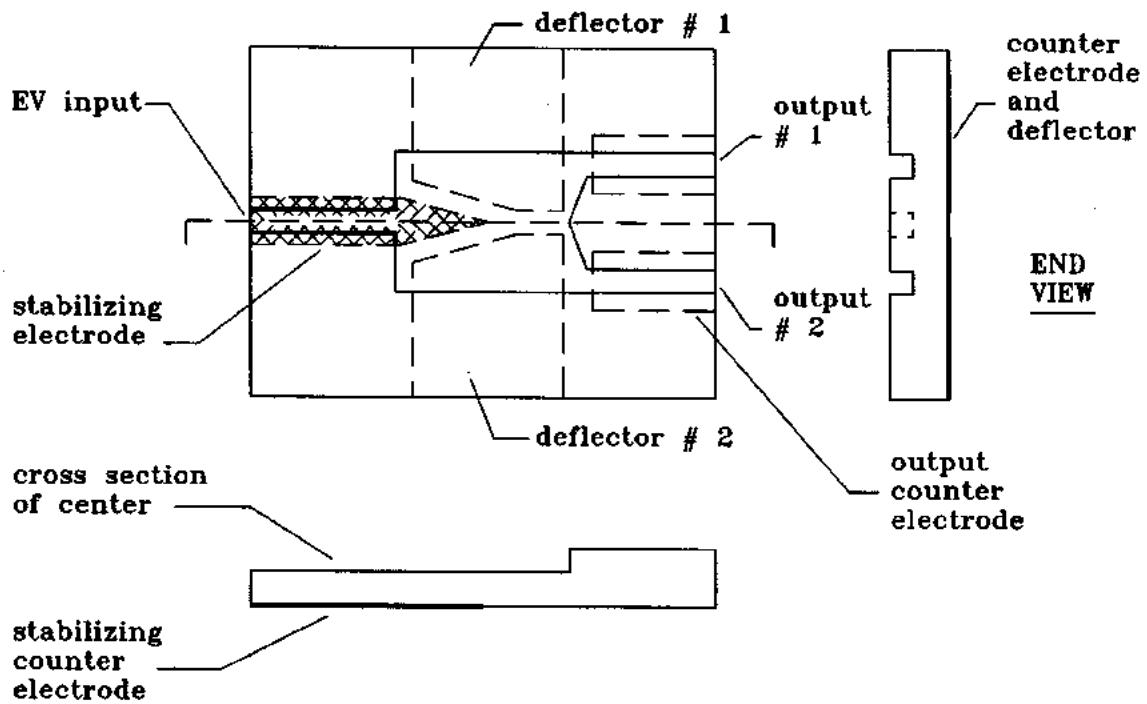

Figure 8:19

region, the deflectors can be maximally effective before the EV is once again entered into a strong guidance region for further propagation. It is obvious that the transition from the original guide to the low stability region must be done in a manner that does not set up transients in the EV path; otherwise spurious switching can result. There is a useful analogue between EV switching and the switching methods used in fluid logic, even to the extent that feedback can be used to completely relieve the effect of input loading or coupling. In such EV circuitry, there is a considerable advantage in having the feedback use electromagnetic components operating near the velocity of light to circumvent delays that would otherwise produce poor transient response. Conventional R, C, and L components work well with EVs traveling about $1/10$ the velocity of light.

Figure 8:19 is a drawing of a film version of an EV deflection switch. The most peculiar aspect of this device is the way an EV is entered into the deflection region. In the drawing there is a stabilizing counter electrode shown under the entry guide. This is one method for inducing the EV to proceed across the deflection region without showing instabilities in motion. An alternate method (not shown on the drawing) of introducing an EV into a deflection region with low disturbance is based upon mechanically tapering the inlet guide in the thickness dimension until it is no longer effective in guiding the EV. This method is not easy to reproduce in photolithographic technology. Strong, bistable switching action can be achieved by producing a geometry that is abrupt at the entry region between the guide and the deflector. Of course, more deflection voltage is required in this case. Another variation not shown in the drawing is produced by using resistive termination of the deflectors and letting this deflector region cross the EV path. Dielectric charging is prevented by using this deflection method.

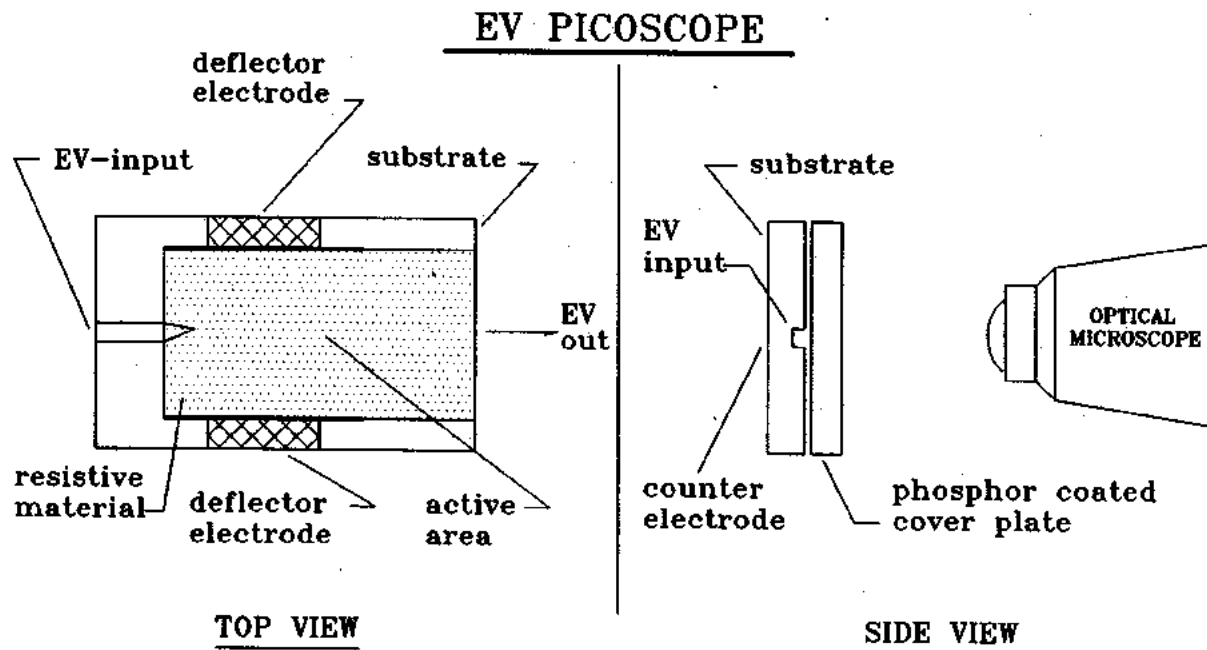

Figure 8:20

EV Picoscope

By extending the quality of the stabilizing and deflection methods of the EV switch, it is possible to produce a type of oscilloscope that is capable of displaying very high speed waveforms. This device is shown in Figure 8:20 and Figure 8:21. Figure 8:21 can be recognized as the electron camera and, indeed, embodies many of the elements of the electron camera with a few additions to the region where the EVs operate. The camera is used to look down upon the structure shown in Figure 8:20 and present an image of the EV motion on the surface. The motion on the surface is not a true function of the potential impressed upon the deflection electrodes but rather an integral of the function. In spite of this the picoscope is still a good device for viewing fast waveforms.

The motion of the EV can be viewed directly with a microscope if a phosphor coating is applied to a cover plate located a short distance from the surface on which the EV is running. This configuration is shown on the right side of Figure 8:20.

ELECTRON CAMERA

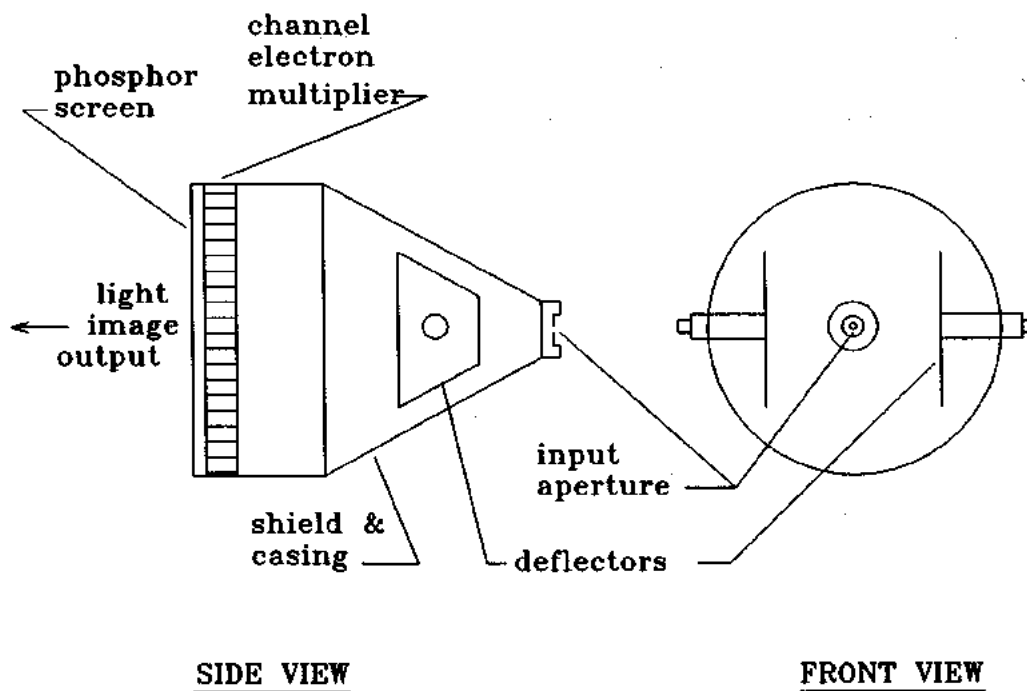

Figure 8:21

When using this technique for high speed work, it is necessary to keep the input leads as short and small as possible. For most work in the range of this instrument it is most desirable to practically imbed the scope in the region generating the signal. These essentially become "chip scopes" and should be considered practically disposable.

For changing the sensitivity and sweep speed of the scope, it is almost necessary to change the entire device geometrically, or at least to view a longer EV run for longer sweep times. One cannot yet vary the EV velocity over a sufficient range to get all of the timing range desired. For timing and synchronization of waveforms, it is necessary to use almost every EV trick available, because conventional transistor circuitry is not easily adapted to EV technology.

EV COUPLING TO TRAVELING WAVE CIRCUITS

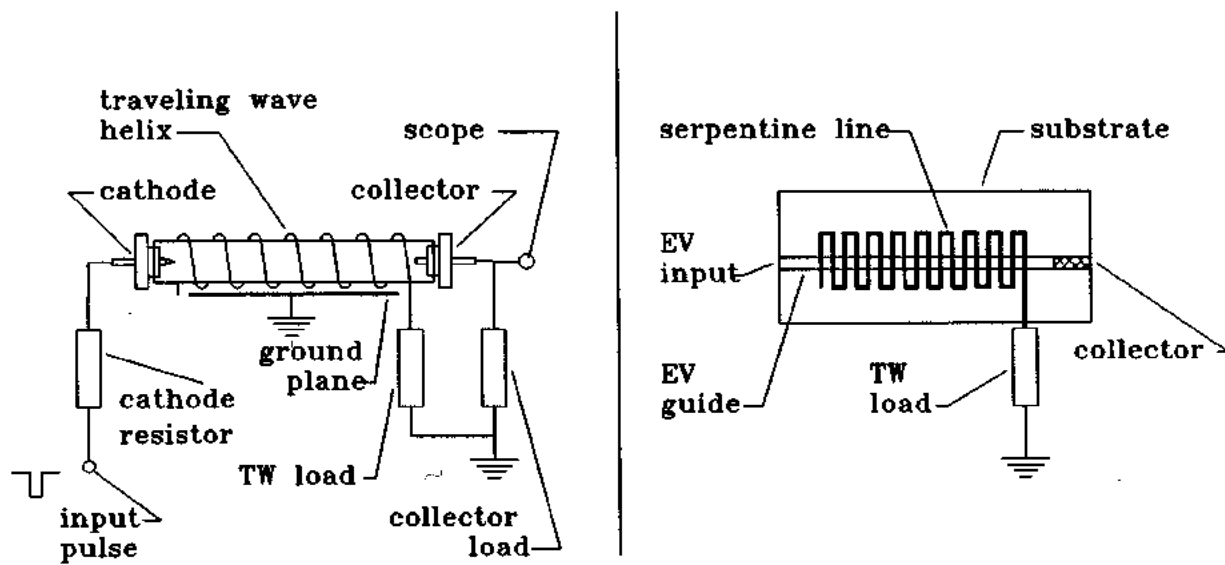

Figure 8:22

Traveling Waves

Since an entire chapter has been devoted to the trials and tribulations of the operation of traveling wave devices, it is only necessary to describe some of the apparatus here. Figure 8:22 shows two drawings that may shed some light on the configurations used. The heart of the device shown on the left is a dielectric tube of either glass or ceramic. A coil of wire is wrapped on this tube in such a way that it just overlaps the cathode and the collector. A load is put on the end of the delay line formed by the coil and associated ground plane. This load must match the impedance of the line to minimize reflections. The cathode is pulsed with a negative going pulse of from 1 to 2 kilovolts applied through a resistor of from 500 to 1500 ohms. This resistor is used to protect the cathode and to help determine the current being delivered to the cathode. A 50-ohm resistor is also connected to the collector going to the scope.

In our particular operation, the entire apparatus was operated in an oil-diffusion pumped-vacuum system and xenon gas was bled into the tube. This allowed us to rapidly change cathodes and other appendages without getting leaks. As far as experimental technique was concerned, this device operated very well. It is just that there was some basic difficulty with the concept of interacting coherent structures that made repeatability very poor.

The right side of Figure 8:22 shows a film equivalent of the traveling wave apparatus. The slow wave circuit can be any number of layouts but this one shows a serpentine line. An interdigitated structure would do well here also.

Optical Guides

Although this paragraph is going to be an extremely thin offering for a device or component, I still feel inclined to comment on what has been seen in the way of optical guidance for EVs. There is a day coming when this effect will be understood and thus become a powerful addition to the EV arsenal.

The apparatus that first showed the effect is shown in Figure 6:1 and is the apparatus in which most of the streamer work was done. When streamers rise up from the center electrode and strike the top, they turn and run radially on the flat surface of the cover glass. The run is not entirely straight as they approach the cylinder wall, but at times there is a fair approximation to a radial line. When this happens, and the line is viewed from the end in the plane of the top, a bright scintillation can be seen. If a piece of white paper is placed around the cylinder, many scintillations and streaks can be seen.

In order to make the effect more obvious, I caused streamers to run in long glass tubes by exciting them with short bursts of RF at a frequency of between 1.7 and 5 MHz. About 10 cycles of RF was the minimum that I could conveniently generate. Under the conditions

EV POINT X-RAY SOURCE

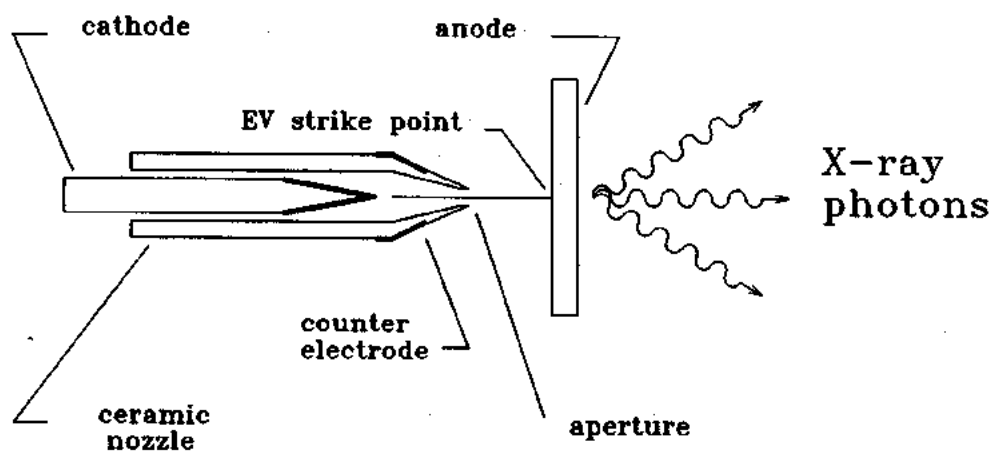

Figure 8:23

that produced small, thin streamers, these streamers would run for a distance of 2 inches or so on the inside of the 3 mm glass tube without turning. Then they would suddenly deflect a small angle and then run straight again. By looking at the deflection point it could be seen that the deflection was caused by something on the surface. I put small grains of various substances in the tube to see what the effect preferred; silica sand was the winner. The sand had bright faces, or facets, and I reasoned that it was this optical surface that caused the turn. I also applied the sand to the center electrode and found that it would cause the launching of a streamer whenever the conditions of angle and field were correct. There was no way to control the process with the apparatus used and the effect was strictly a statistical one.

Someday we will get a control on the effect and it may prove to be a laser-like process generating the beam that the EV then rides upon. That would be a nice synergy, but one I have come to expect within the EV field. If such guidance does become practical, there is a good chance for focusing enormous energy density from multiple sources that are a lot easier to make than conventional lasers.

Point X-Ray Source

The EV point X-ray source can be a simple component of some system. I mention it in passing because it is there, and someone may be able to make something out of it someday. Figure 8:23 shows an EV source and a target with sufficiently low inductance to cause the EV to rupture (or at least that is the way I think of it) and in doing so, emit X-rays.

Circulators

Circulators are another component that there has been no time to work on, although they are as important as any other component. In some ways I hope the energy-storage capability of circulators will not be high enough to make them competitors in energy density with chemical explosives. I do not have good visions at all when I think of an electrical bomb, but all energy-storage devices are potentially dangerous.

When guides are worked up to a highly refined state, can circulators be far behind? If the materials of circulators can take the gaff, and large currents of EVs can be circulated, the generation of magnetic fields will produce the ability to span gross physical gaps and produce magnetic bearings and motors without magnetic materials. Super-fine control of these fields is an inherent part of EV technology. As magic as all of this seems to be, I would not expect these circulating currents to continue without a drive field. After all, the stored energy of electrons is pretty low, and even superconductors have lower magnetic field limits than is desirable. High frequency drives, in the sub-millimeter range, is the natural choice for small drives while scaling will allow lower frequencies for the larger machines.

Computers

All of the components necessary for some rather interesting computers seem to be available within the bounds of EV technology, but the power level is far too high with the present bead size we have, although there are some charge-steering techniques using deflection switches that could use large EVs to their best advantage. Just a moment's reflection on the voltage change produced by an EV on a typical structure will show why the present EVs are too large. Take, for example, a 10-micron cube of material with a dielectric constant of 5, having electrodes on a pair of opposite cube faces. The computed capacity of this geometry is around 5×10^{-16} F. Only 3×10^5 charges are needed on this capacity to produce 100 volts. One EV bead carries around 10^{11} charges and would blow the capacitor to bits if an attempt were made to store all of the charge on the capacitor. It would be necessary to drop to a bead size of only 0.01 microns, or 100 angstroms, diameter to provide this charge. I can't say that I have ever seen such a small EV and it may not even be possible.

The major implications here are that an EV is presently too large for the simple computer functions that are presently practiced. It is not just a question of simple power dissipation, it is one of being a major threat to the very existence of the machine. What is needed for the EV is a method of computation that uses the same EV many times over before the order is destroyed. The method of choice would be more like current steering logic, some multi-aperture magnetic device work, superconductive logic, or possibly a form of neuristor circuitry. At the moment I can see some special, super high-speed front-end logic being performed on certain input information, but for most functions, the presently available low-energy-level semi-conductor components have a lot to offer and are the winners.

Where to from Here?

Any reader who has managed to stick it out through most of this book may have noticed that the real data started thinning out toward the end. It even gets thinner from here on, but hang on because we do not have far to go.

The real beauty of EV technology lies in the fact that they seem to offer not just a variation on the same old themes of component and system building, but rather a gateway into an entirely new realm of fabrication and performance. The EV is a new substance! It practically creates itself, and is more than ready to form into vast new organisms with only a little help from us. I have dreamed, prayed, proclaimed, ranted, and raved about new organizational methods for many years now, long before the EV showed up, and now at last one is finally in sight with all of the necessary prerequisites for growing itself almost alone.

The electronic entities to be formed will not look or be like anything ever written about in science fiction, although I am sure someone has foreseen them. I hope we can knit them into something that aids our culture. I would like to see the time come when such an entity, with all of its power and intellect, would fulfill our hopes for a truly great self-organizing form of artificial intelligence.

Chapter Nine

GUIDELINES FOR EV THEORIES

There are many EV observations that can be made to fit loosely under one set of rules that seem to coalesce into a theory of EV containment and propagation. I am going to submit these observations in the form of a rough theoretical outline, as if a final theory will emerge from this beginning. Considering that this work is in such an early stage of development, it would be a surprise to me if the emergent theory were very close to this preliminary effort.

Gradient Focusing

Since the EV is such a ubiquitous device, it follows that any containment scheme associated with it must also be universal and easily reproduced. In searching for a convergent, self focusing process to contain the electrons in the tight little bundle we see, I have been led to consider strong focusing techniques originally used in particle accelerators. Here is a technique that is more universal than it might originally appear. This method is at the root of alternating gradient focusing; monopole, quadrupole, and spirupole mass spectrometers; optical containment of particles; and a host of other particle manipulation methods. The convergence process at work in all of these applications is a dynamic process. The process stems from the time average of an alternating force (on the contained particle in an inhomogeneous field) being driven toward the region of the weaker high frequency field, which must be the center of the container. Frequencies for achieving this containment effect extend from low audio range to the optical region. This is indeed a universal process and it seems applicable to containment of electrons with the density of those found in an EV, provided sufficiently high frequencies and amplitudes are used. Before I am through describing this containment process, I am going to ask you to believe that it is possible to contain electron pressures equivalent to billions of atmospheres with radiation.

Spherical Monopole Oscillator

A second requirement of major importance is to find a containment geometry that naturally occurs whenever the initial process of forming an EV begins. This geometry must also be consistent with the needs of the containment technique in providing a convergence, while at the same time not allowing the motion of the electrons contained to radiate all of their

energy to space. It is possible that the simplest imaginable configuration of spherical compression is the shape of choice. This geometry results quite naturally from the plasma blowup that follows, along the lines described earlier in Chapter Eight in the section on short EV generators and from the description of Mesyats [Mesyats, 1982, 1983]. There is also something similar to a spherical electron blowup formed when a field emission source, initially operating under space charge repulsion, is pulsed with a very short pulse, although this source would also seem to contain toroidal components of motion.

Internal Modes

The largest concern with the spherical geometry comes when one considers the radiation from the electrons oscillating and converging in their self-generated field. In the ideal case, the radiator would be classed as a monopole and this would be incapable of radiation, a very desirable feature for low loss, but one that then becomes suspect of not having sufficiently interesting internal fields for supplying the focusing action. I will also have to assume that dipole and quadrupole fields will radiate excessively, and thus remove themselves from the structure, perhaps leaving their electrons for containment by another more conservative segment of the container. In such a matter as this, I will just have to wait until someone else makes a pronouncement. For the moment I will adopt the spherically oscillating charge, assume it has the ability to self-form the internal states for producing the desired convergence from the initial formation energy, and move on to the process that maintains the oscillations of convergence.

Zero Point Fluctuation Drive

At this point I can fall back upon the paper of Bergstrom [Bergstrom, 1973] mentioned earlier and claim that the motion of contained charges is indeed what binds them to the remaining charges forming the entity. At this same juncture, I can step over into the holy region of the vacuum, or polarizable ether, as Bergstrom called it, and begin to look for the sustaining process that keeps the entity intact for longer than would seem possible from initial energy input considerations. I will invoke zero point fluctuations as the ubiquitous energy source to sustain the life of the EV.

Puthoff [Puthoff, 1987] has shown that the ground state of hydrogen is a zero-point-fluctuation-determined state and that this carries with it the attendant implication that the stability of matter itself is largely mediated by ZPF phenomena in the manner described, a concept that transcends the usual interpretation of the role and significance of zero-point fluctuations of the vacuum electromagnetic field. I claim that the initial motion of electrons set up at the time of an EV formation is kept in equilibrium or compressed further by the electromagnetic input from the zero-point fluctuations.

Reformation

In any complex process, such as the one just described, it would not be likely for the process to freeze at the moment of formation and never change again. Indeed, the opposite is implied. The more complex a process, the more likely it is to continue changing state with time until a final low-energy equilibrium is reached. I would expect an EV to be a ragged thing initially due to the unsymmetrical fields that determined its formation. Once the entity wrested itself free of the formation region, I would expect a high degree of conformity with the container but that it would still have a life of its own. I would also expect that there would be a chance that it would reform into a more ordered structure that has a relatively narrow radiation linewidth. This reformation may cost the loss of some electrons, as we have witnessed with the electron camera. We have seen how amulets reform and how, in doing so, they eject electrons that cannot be accommodated. Reflecting back upon the photographs of the bead chains, and knowing that these results represent not only the influence of the containers for the beads but also the force that binds the beads together, we see an absurdly complex electromagnetic field configuration having many bound nodes in a harmonic sequence. It is a wonder that any change can be made in the structure without a total disaster. This is simply a wondrous process.

Container Size Limits

If this container process follows normal laws of nature, we would expect that the lower size limit would be strongly affected by surface-to-volume-ratio considerations. In all likelihood, there is a minimum-size bead that can be made with a particular rate of energy input to the process. Bergstrom [Bergstrom, 1973] declares that the same process of containment is good for things ranging from the size of an elementary particle to ball lightning. Perhaps so, but it will take pair production energy densities to form an electron positron pair. The EV, having a much smaller surface-to-volume ratio, would not seem to require such a high energy density for formation.

There is also this matter of why the bead size seems to be predominantly 1 micrometer in diameter. Above this size, the process just seems to prefer to form other beads instead of growing larger beads. My guess at this point is that the disturbance we introduce into the formation process has something to do with the maximum size attainable. It may be analogous to blowing bubbles. High pressure and high velocities, creating turbulence, do not make nice big bubbles. It takes low velocity undisturbed air to make large bubbles. This is the weakest kind of statement that can be made, but I feel inclined to offer something here since the size of a bead is such a characteristic thing. In a more scientific vein, it would also be interesting to look at vacuum breakdown or sparking as the nonlinear mechanism that limits the size of a bead to the one-micrometer-diameter region.

Container Summary

Up to this point, the process I propose for formation of an EV is this: an externally driven process of compression, which strives for something roughly spherical, is followed by a rebound that produces a self-excited field operating in such a way as to converge the electrons toward the time-varying, field-deficient center of the spherical monopole oscillator that is developing. This oscillator is coupled to the ZPF fields and is sustained. There is a regrouping of charge and fields, both within and outside of the newly formed entity, until an equilibrium is reached. This equilibrium may be the incognito state of an EV, called a black EV, and could be closely related to an excited state of the vacuum.

Surface Field Measurement

Consideration can now be given to some of the external manifestations that have perplexed us. In particular, why does the EV not show the megavolts of field that one would calculate from considering the number of charges present in the radius indicated by the witness plate strikes? Most of these measurements are made by observing the velocity of electrons either given off by the EV or electrons approaching the EV from outside. In both cases we see only kilovolts of energy at best. The solution to this mystery is that the container action of the EV has isolated the fields of the EV core, and all that we have access to is the surface of the container. This surface extends a considerable distance beyond the actual region containing the electrons, and so our radius measurements using the witness plate radius are false. This is the correct inside size for the container, but it does not represent the region of interest when using either emitted or incident electrons to probe the fields. There is, in effect, a work function associated with the container, and this can be overcome either by thermal-like or tunneling processes. In addition, one must consider the effective field reduction caused by the container overcoming the space charge repulsion force.

Maximum Energy Extraction Rate

Since the ZPF energy supply rate is limited (probably by coupling considerations) there is a finite extraction rate of energy from the electrons in the potential well created, before the stability criterion for the well is exceeded. If this rate is exceeded, as it may well be upon contact between an EV and a metal, then the EV explodes, giving up its container energy into whatever region of the radiation spectrum is most appropriate. There are indications this may be the soft X-ray region for 1 micrometer beads. An indicator of a useful energy supply rate from the vacuum can be gleaned from the data on how an EV bores its way through aluminum oxide, as described in Chapter Five, EV Targets. The constant diameter of the bored holes suggests that the device doing the boring was either very high in energy

content, and hardly affected by the operation, or that it was being resupplied with energy as it went. I choose the latter explanation. I would like to point out again what a high stiffness must exist within the boring entity, and that this implies a high radiation energy density for the container. One could even think in terms of the radiation being used as a plug to prevent the escape of material in the rearward direction while the pressure at the front was determined by the vapor pressure of aluminum oxide.

Communication with Guides

When the EV is normally formed, and proceeding in a guidance channel, it will be in constant communication with the guide. The coupling is likely to be emission from the containment frequencies, which may be in almost any radiation band from submillimeter through X-ray. Some of these emissions would be returned from the guide to the EV, and they would constitute a sensor-and-servo system to maintain proper positioning in the guide. It should be clear that high-loss material for guides could have adverse effects upon the guidance system. Observations on some EVs operating in vacuum, without the advantage of a nearby guide, show that they are stressed to the point of extinction. Other EV structures do much better, presumably because they radiate less. The internal structure of the EV would thus dictate its lifetime when using this scenario. The reverse of this situation is seen when an EV proceeds through even very low gas pressures, especially through high-atomic-number gases. In this case the long lifetime of the EV might be traced to the shielding action of the excited gas.

Soft Boundaries

It has been noted that an EV has a state in which it can move through gas without causing any apparent ionization. These interaction measurements do not extend to extreme sensitivities, but, for a given set of conditions, the EV suddenly goes black, perhaps appearing later, but for a time essentially disappearing in terms of electron, ion, or light emission. I believe that the high-frequency-containment theory can cover this state without too much trouble. It appears to me that the fields reaching out from the EV could have the proper gradients, and sufficiently low frequencies, to present a "soft" effect on nearby objects, such as molecules, and to be able to sweep them aside without exciting them to optical transitions or ionization.

Polarization

When we think of the attachment force that binds an EV to a dielectric guide, we normally think in terms of the direct current polarization, and there should be plenty of that around an EV. With the container model we now have in mind, we must also consider the high frequency polarization effects that would surround the EV. I assume that these would be

effective up to the resonant frequency of the material being used for the guide. In considering polarization, note that this can be considered a bilateral process. In my opinion the EV is also deformed slightly whenever a direct current polarization field is present. Later, this will come into play when we consider the propagation properties of an EV.

Consolidation

There is a slightly disturbing prediction from the model suggested here: one might suspect accretion of charge onto the largest structures until "mother beads" or ball lightning had formed. There would be a necessity for exciting the entire structure at low amplitude and waiting for the process slowly to occur, dissolving out the smaller kinks and depositing them onto the larger structures. If this type of process *does* occur, it would play hob with my intentions of forming stable, complex structures with EVs. I can only hope EV laws of organization follow those of chemical binding but are somewhat elevated in their binding energies.

Charge Density Modulation

Another prediction that comes from the model chosen is that a variable-dress charge would be available from the EV. If the effective radius of the container is associated with the state of excitement, then this would appear as a charge density modulation to a fixed observer located on the edge of the guide. This is a bilateral effect and would seem to have regenerative properties. In this light, an electrode would be responsible for exciting the EV and in turn the EV would excite the electrode. Many devices can be devised using this principle.

Optical Beam Source

An earlier chapter noted that streamers formed by an EV were frequently seen to be guided by what appeared to be an optical beam. Using the guidelines proposed here, it is clearer to me how this could be accomplished with the highly organized system of radiation sources surrounding the EV. Using even the simplest considerations of radiation from a line of oscillating charges, a beam of radiation in the fore and aft direction would be expected. I would not be surprised to find that certain easily available configurations and vibrational modes between EVs did indeed produce tightly beamed actinic radiation that could ionize a corridor ahead of the EV, producing a favorable path for propagation. This relatively fast photon beam, going ahead of the EV, would seem to help set up a straight guidance path. This straight guidance channel would, in turn, help provide a more tightly bound beam, and so forth. This seems to be a logical explanation for the straight streamers we see produced in gas.

EV Propulsion

I believe an EV is being propelled by radiation stemming from a very slight distortion of the radiation container discussed here. The distortion I envisage would be produced by application of a steady field from a simple voltage on an electrode, by a standing or running wave field, or by polarization in a dielectric material. The distortion produced would have to modulate only a small fraction of the total radiation energy available in the container to produce propulsion. With this method, as long as there is a small gradient available to distort the EV, there will be motion toward the applied field. To get a feel for the throttling power available with this method, consider the aluminum-oxide-boring trick where something like the feeble applied direct current, or the residual polarization, controlled the gigantic amount of radiation release needed to do the boring.

The field for applying this distortion can be either static or dynamic. I would expect an EV to be fully capable of responding to field gradients on optical beams, and therefore to be capable of riding an optical beam out of the initial EV generation region. Furthermore, I also expect the EV itself to be the best generator of the optical fields for propagation. There have been many instances seen in the laboratory where the EV has gone past the electrodes that were used to apply the direct current fields. These were largely accidents, and no effort had been made to set up traveling waves in space to extend the flight of the EV past the electrodes. Structures for doing this are not hard to imagine. It would not surprise me to see the EV brought to a halt, by manipulation of these space fields into standing waves, in much the same manner as ball lightning is reported to behave.

At the other end of the velocity scale, it is quite likely that the velocity of an EV will be found to exceed that indicated by the direct current potentials applied. The EV is not an electron. It is a complex engine and capable of performing feats associated with more complex systems. With this notion in mind, it is quite reasonable to assume that the velocity of an EV driven by radiation pressure will reach an equilibrium anywhere between zero and near the velocity of light. I have often wondered if a black EV was not just a plain vanilla EV that somehow got to going so fast it was difficult to see.

Vector and Scalar Potentials

In the earlier years of research, before the EV project was found, a lot of work was devoted to electromagnetic field considerations, using vector potentials and scalar potentials instead of magnetic and electric fields. Although these two methods can always be mathematically derived from each other, there is a profound difference in engineering end-results obtained

when using thought processes derived from one or the other. There were a great many mysteries produced in this area as we tried to use potential effects for both communication and charge compression. By some irony of fate we may have folded back upon ourselves, and now have accidentally discovered the EV as an ideal monopole oscillator. This oscillator is the perfect generator for vector and scalar potential waves without contamination from either E or B fields. These waves can be thought of as longitudinal waves in the vacuum. They are largely undetectable by standard E and B detecting means but are readily accessible to the monopole world. There appears to be an incredibly large number of useful phenomena yet to arise from using potential effects that are not immediately accessible to the force of E and B fields. This phase determined, force-free world will certainly be another chapter somewhere in the future.

Epilogue

The condensation of my thoughts and the writing of this book have been just another phase in the constant cycle of searching the universe of the physical sciences.

A new part of the cycle is coming soon in which the results of the search will be disseminated and converted into useful products.

Following this, I will return to exploration of the vast electronic wilderness just discovered. This cycle of search, discover, and exploitations is, to me, just about as great as anything could be.

This episode has ended, but the story as a whole is *To Be Continued*.

References

- Bergstrom, Arne. Electromagnetic Theory of Strong Interaction. *Physical Review D*, Vol. 8, No. 12, 15 Dec. 1973, pp. 4394-4402.
- Boyle, W. S., Kisliuk, P. P., and Germer, L. H. *Journal of Applied Physics*, Vol. 26, p. 720, 1955.
- Kisliuk, P. P. Bell Laboratories Records, Vol. 34, p. 218, 1956.
- Lafferty, J.M. *Vacuum Arcs Theory and Application*, John Wiley and Sons, 1980.
- Malmberg, J.H. and O'Neil, T.M. Pure Electron Plasma, Liquid and Crystal, *Physical Review Letters*, Vol. 39, No. 21, 21 Nov. 1977, pp. 1333-1336.
- Mesyats, G.A. Fast Processes on The Cathode In A Vacuum Discharge, *IEEE Proceedings*, Xth International Symposium on Discharge and Electrical Insulation in Vacuum, October 25-28, 1982, Columbia, South Carolina, pp. 37-42.
- Mesyats, G.A. Explosive Processes On The Cathode In a Vacuum Discharge, *IEEE Transactions on Electrical Insulation*, Vol. EI-18, No. 3, June 1983, pp. 218-225.
- Nardi, V., Bostick, W.H., Feugeas, J., and Prior, W. Internal Structure of Electron-Beam Filaments, *Physical Review A*, Vol. 22, Number 5, November 1980, pp. 2211-2217.
- Puthoff, H.E. Ground state of hydrogen as a zero-point -fluctuation-determined state, *Physical Review D*, Vol. 35, No. 10, 15 May 1987, pp. 3266-3269.
- Schwirzke, F. *Laser Interaction and Related Plasma Phenomena*, Vol. 6. Edited by Heinrich Hora and George H. Miley. Plenum Publishing Corp., 1984, p. 335.
- Schwirzke, F. Unipolar Arc Model, *Journal of Nuclear Materials*, 128 & 129, 1984. pp. 609-612.
- Shoulders, K. Microelectronics Using Electron-Beam-Activated Machining Techniques, *Advances In Computers*, edited by Franz Alt, Vol. 2, Academic Press, 1961, pp. 135-293.
- Shoulders, K. Toward Complex Systems, *Microelectronics And Large Systems*, edited by S.J. Mathis and R.E. Wiley, Macmillan and Co., 1965, pp. 97-128.

INDEX

A

- aluminum oxide film, as target, 5-18
to 5-23, 5-26
- aluminum oxide particles, causing
electron emission, 4-38
- anode current values, 4-3
- apparatus, tools, and devices, 1-9
 - circulators, 8-49
 - computers, 8-50
 - deflection switch, 8-39, 8-41
illustration, 8-40
 - designing, 1-11
 - electrodeless source, 8-11
illustration, 8-10
 - EV generator, 2-5
illustration, 2-6
 - film field emission EV source, 8-19
illustrations, 8-20 to 8-21
 - film LC guides, 8-31
 - gas diode
 - fabrication of, 3-21
illustration, 3-20
 - gas EV guide, 3-25, 4-41
illustration, 3-24
 - gas triode, 3-15, 3-21, 3-22
illustration, 3-14
 - guides, 8-27
illustrations, 8-26
 - launcher, 8-9
illustration, 8-9
- apparatus, tools, and devices
(Continued)
 - LC guides, 8-29, 8-31
illustrations, 8-28, 8-30
 - Marx generator, 1-11
 - metal vapor sources, 8-5
illustration, 8-4
 - mosaic guide for EVs, 2-12
illustration, 2-13
 - multielectrode sources, 8-22
illustrations, 8-23 to 8-24
 - nozzle structures
 - for EV sources, 2-16
 - optical guides, 8-47, 8-49
 - oscilloscope
 - requirements for, 3-26 to 3-28
 - picopulser, 3-26 to 3-27, 4-21, 4-40,
8-16, 8-19
illustration, 8-17 to 8-18
 - picoscope, 4-20 to 4-21, 8-43, 8-45
illustrations, 8-42, 8-44
 - pinhole electron camera, 3-28, 3-31
calibration of, 4-1, 4-7 to 4-9
illustration, 3-29
magnification used, 4-6
pictures, 3-30
 - point x-ray source, 8-49
illustration, 8-48
 - pulse power supply, 4-2 to 4-3
 - RC guides, 8-27, 8-29
 - resistor (EV circuit), 8-15
illustration, 8-14

apparatus, tools, and devices
(Continued)
 RF generators, 8-33
 illustration, 8-33
 scanning electron microscope
 purchase of, 1-9
 selectors, 8-37, 8-39
 illustration, 8-36
 separators, 8-13
 illustration, 8-12
 splitters, 2-14, 8-39
 illustrations, 8-38
 streamer formation chamber, 6-4
 illustration, 6-3
 surface source, 8-7
 illustration, 8-7
 synchronizer, 8-32
 traveling wave circuit, EV coupling
 to
 illustrations, 8-46
 tubing, fused-quartz, 4-55 to 4-58
 waveform measurement device,
 4-20
 argon gas, for producing streamers,
 6-2
 Austin, Tex., laboratory moved to, 1-9,
 4-64

B

ball lightening, possible formation
 of, 9-6
 bead-shaped EVs
 binding energy of, 3-7
 characteristics of, 3-1
 circular structure of, 3-3, 3-5, 3-7
 discovery of, 2-23
 high surface-energy gradient of,
 3-3, 3-5
 one-micrometer size of, 3-3, 3-5,
 9-3
 pictures, 3-2, 3-4, 3-6, 3-7
 spacing of bead chains, 4-23
 sweep experiment, 3-3

bead-shaped EVs *(Continued)*
 tangled state of, 3-1, 3-3
 Bergstrom, Arne, 1-10, 9-2, 9-3
 black EVs, 2-15, 9-7
 cause of fading, 4-47
 definition, 3-21 to 3-22
 flaring, 3-25
 gas pressure and, 3-25
 pictures, 4-46
 precursor messengers, 3-25
 blinking of EVs, 4-10, 4-12
 pictures, 4-10, 4-11
 boring through materials. *See*
 dielectric materials/surfaces
 Bostick, Winston, 1-6 to 1-7, 1-10,
 2-2
 Boyle, W.S., 2-1
 brightness of deflected EV,
 nonuniform, 4-27

C

calculations
 charge calculations, 4-6
 emission calculations, EV, 4-9
 carbon/chromium film, as target, 5-1
 to 5-3
 conductive backing added, 5-3 to
 5-5
 pictures, 5-2, 5-3, 5-4 to 5-5
 carbon without chromium, as target,
 5-5 to 5-7
 picture, 5-6
 cathode ray tubes
 activated by EVs, 8-37
 cathode spots
 as argument against EVs, 6-7
 cathodes
 for EV generation, 2-5, 2-9, 2-15
 to 2-16
 EVs used as special cathode, 8-35,
 8-37
 for oscilloscope, 3-27 to 3-28

cathodes and anodes
 arcing between, in scanning
 tunneling microscope, 5-14 to
 5-15
 channels, EV generation and, 8-25
 charge calculations, 4-6
 charge collection, 4-2
 charge density modulation, 9-6
 charging surfaces
 early studies, 2-11
 problems caused by, 2-15, 5-25
 Church, Bill
 biographical sketch, 1-4 to 1-5
 financial (and other) support from,
 1-8
 picture, 1-3
 circulators (energy storage devices),
 8-49
 coaxial diodes, 3-17, 3-21
 pictures of effects, 3-19
 coaxial line EV generator
 illustration, 3-18
 collector electrode, 4-21, 4-27, 4-30,
 8-35
 collision experiments, 2-14 to 2-15,
 2-18
 components and devices. *See*
 apparatus, tools, and devices
 computers, using EVs, 8-50
 consolidation of EVs, 9-6
 consorting of EVs, 4-16 to 4-17
 pictures, 4-17 to 4-18
 containment of EVs
 container size limits, 9-3
 gradient focusing, 9-1
 reformation of structure, 9-3
 spherical monopole oscillator,
 9-1 to 9-2
 summary of theory, 9-4
 zero point fluctuation drive, 9-2

D

damping forces of EVs, 3-11

deflection switch, 8-39, 8-41
 illustration, 8-40
 deflection tests, 4-19 to 4-27
 deflector electrode, 4-21
 delay line, for traveling wave tests, 7-2
 devices. *See* apparatus, tools, and
 devices
 dielectric materials/surfaces
 boring through, by EVs, 5-17 to 5-20
 pictures, 5-18 to 5-20
 charging of, 2-15
 for EV generator, 2-5
 EV runs on, 4-41, 4-43
 pictures, 4-41
 multiple hole boring, 5-25 to 5-26
 picture, 5-25
 reboring small channels, 5-21, 5-23
 pictures, 5-22, 5-24
 diffraction effect of EVs, suspected,
 4-36, 4-38
 pictures, 4-37 to 4-38
 direct current glow discharge, 3-21
 direct current output devices, 8-35
 discharge trails, 2-11
 display devices, activated by EVs, 8-37
 "dog house", 2-16, 4-19, 5-23, 8-13
 dual energy levels, 4-51
 picture, 4-50

E

electrodes, collector and deflector.
See collector electrode;
 deflector electrode
 Electromagnetic Vortex, first name for
 EVs, vi
 electron camera. *See* pinhole electron
 camera
 electron emissions from EVs, 4-14,
 4-16, 4-27, 4-30, 4-38
 used as a cathode, 8-35, 8-37
 electronic entities based on EVs,
 8-50

electrons
 condensing to a solid, 1-10
 cooling of, 1-10
 lost in transit, 4-6
 necessary for EV sources, 6-8 to 6-9
 Electrum Validum, name for EVs, vi
 emission calculations, EV, 4-9
 emission modulation, 4-27, 4-30, 4-32
 pictures, 4-27 to 4-29, 4-31 to 4-32
 emission sources for EVs. *See*
 sources of EVs
 emission spectrum measurement, 3-27
 energy analysis, 4-12
 pictures, 4-13
 energy extraction rate, maximum, 9-4
 to 9-5
 energy source, for generating EVs, 2-7,
 2-9
 enhanced electron mobility effect,
 4-36, 4-38
 pictures, 4-37 to 4-38
 ether theory of Bergstrom, 1-10, 9-2
 EV actions
 blinking, 4-10, 4-12
 pictures, 4-10, 4-11
 consorting, 4-16 to 4-17
 pictures, 4-17 to 4-18
 jumping along a surface, 3-11
 turning behavior, 4-14, 4-16
 pictures, 4-15, 4-16
 EV generators, 2-5. *See also* generation
 of EVs; sources of EVs
 EV launcher, 8-9
 illustrations, 2-6, 8-9
 EVs. *See also* bead-shaped EVs; black
 EVs; witness marks and plates
 analyzing with the SEM, 2-9, 2-11
 definition, vi, 8-1
 first appearance of, 1-12, 2-1
 lingering of, after pulse termination,
 3-17
 literature search relating to, 2-1
 naming of, vi
 properties of, summarized, 4-63
 to 4-64

EVs (*Continued*)

video images of, 3-32 to 3-39
 well-defined dimension of, 5-18

F

field emission diodes
 coupled with picopulser
 illustration, 8-18
 as sources, 8-15 to 8-16
 as targets, 5-17
 pictures, 5-16
 field emission processes, 3-22
 field-free regions, lack of, around EVs,
 3-11 to 3-12
 field measurement of EVs, 9-4
 film LC guides, 8-31
 fission-fusion of EVs, 2-18 to 2-19
 flaring, 3-25
 Formvar-insulated wire, effect of EVs
 on, 3-22

G

gas diode
 fabrication of, 3-21
 illustration, 3-20
 gas EV guide, 3-25, 4-41
 illustration, 3-24
 gas pressure
 effect on EVs, 3-22, 3-25, 4-43, 4-53,
 4-55, 5-13
 pictures, 4-44, 4-54
 in traveling wave tests, 7-3 to 7-4
 gas triode, 3-15, 3-21, 3-22
 illustration, 3-14
 gases
 effect on EV generation, 8-22
 failure of EVs to ionize, 9-5
 inorganic, as source of EVs, 8-9
 organic, as source of EVs, 8-11

gases (Continued)

producing streamers

argon, 6-2

krypton, 6-2, 6-3

xenon, 6-3

gated electron and RF source,

illustration, 8-34

generating EVs. *See also* EV

generators; sources of EVs

basic firing sequence, 8-2

birth cycle of EVs, 8-3

gas and, 8-22

LC guides, 8-29, 8-31

illustrations, 8-28, 8-30

low-energy-level generation, 2-7

pulse duration effects, 8-15

resistor (EV circuit), 8-15

illustration, 8-14

synchronizer for EVs, 8-32

Golka, Robert, 6-1, 6-2

gradient focusing, 9-1

guides for EVs, 8-27

communication of EVs with, 9-5

film LC guides, 8-31

gas EV guide, 3-25, 4-41

illustration, 3-24

illustrations, 8-26

LC guides, 8-29, 8-31

illustrations, 8-28, 8-30

mosaic guide for EVs, 2-12

illustration, 2-13

optical guides, 8-47, 8-49

RC guides, 8-27, 8-29

scaling considerations, 8-31

synchronizer, 8-32

I

inductance of targets, 4-32 to 4-33, 4-35

instrumentation. *See* apparatus,

tools, and devices

ions

apparent lack of in EVs, 4-62 to
4-63

failure of EVs to ionize gas, 9-5

ions (Continued)

ion and electron images, 4-41 to 4-61

J

jitter, time, 2-11, 2-12

jumping of EVs along a surface, 3-11

K

Kisliuk, P.P., 2-1

krypton gas, for producing streamers,
6-2, 6-3

L

laboratory

apparatus, 1-9

buildings for, 1-8

location of, 1-2

moved to Austin, Tex., 1-9, 4-64

pictures of, 1-2 to 1-3

Lafferty, J.M., 2-1, 2-4

laser

electron, 1-10

photon, 1-10

LC guides, 8-29, 8-31

film LC guides, 8-31

illustrations, 8-28, 8-30

load resistor, 4-2

loop of charged particles, 4-55

pictures, 4-54

low electron energy spread, 4-48 to
4-49, 4-51

pictures, 4-49, 4-50

low gas pressure

effect on EVs, 3-22

M

Malmberg, J.H., 1-10

Marx generator, 1-11
May, Ed, picture, 1-3
McCord, Mark, 5-14
measurement of EVs, 3-13 to 3-21
 pictures, 3-14
messengers, precursor, 3-25
Mesyats, G.A., 2-1, 8-2
momentum transfer, 5-26
monopole oscillator
 EV as, 9-8
 spherical, 9-1 to 9-2
morning glory structure, 2-4
mosaic guide for EVs, 2-12
 illustration, 2-13
multielectrode sources, 8-22
 illustrations, 8-23 to 8-24

N

Nardi, V., 1-10
neutral emission, 4-53
nozzle structures, for EV sources, 2-16

O

O'Neil, T.M., 1-10
optical guides, 8-47, 8-49, 9-6
 propulsion of EVs and, 9-7
oscilloscope, requirements for, 3-26 to
 3-28

P

PACER, vi
Particle Compression via Electro-
 magnetic Radiation, vi
periodic structure of EVs, 7-6
Pescadero, Calif., 4-64, 5-1
picopulser, 3-26 to 3-27, 4-21, 4-40,
 8-16, 8-19
 coupled with field emitter, 8-19
 illustration, 8-19

picopulser (*Continued*)
 illustration, 8-17 to 8-18
picoscope, 4-20 to 4-21, 8-43, 8-45
 illustrations, 8-42, 8-44
pinhole electron camera, 3-28, 3-31
 calibration of, 4-1, 4-7 to 4-9
 illustration, 3-29
 magnification used, 4-6
 pictures, 3-30
plasma deflection and cleanup, 4-4 to
 4-5
point x-ray source, 8-49
 illustration, 8-48
polarization around EVs, 9-5 to 9-6
potential well of EVs, 4-12
 modulation of, 4-27
potentials, vector and scalar, 9-7 to 9-8
power supply, pulsed RF, for
 streamers, 6-2
precursor messengers of EVs, 3-25
properties of EVs, summary of, 4-63 to
 4-64
propulsion of EVs, 9-7
pulse emission, thermionic, 4-39 to
 4-40
pulse power supply, 4-2 to 4-3
pulsed RF power supply, 6-2
Puthoff, Hal
 biographical sketch, 1-4
 picture, 1-3
 on zero point fluctuation
 phenomena, 9-2

R

radiation propulsion, induced by EVs,
 5-26
RC guides, 8-27, 8-28
RF generators, 8-33
 illustration, 8-34
ring-shaped witness marks, 2-19, 2-21
 pictures of, 2-20

S

- scalar potentials, 9-7 to 9-8
- scanning electron microscope, purchase of, 1-9
- scanning tunneling microscopes, arcing between cathode and anode, 5-14 to 5-15
- Schwirzke, Fred, 5-15
- selectors for EVs, 8-37, 8-39
 - illustration, 8-36
- separator for EVs, 8-13
 - illustration, 8-12
- Shoulders, Claire, 1-9
- Shoulders, Ken, picture, 1-3
- Shoulders, Steven, 1-9
- size of EVs, 4-23
 - pictures, 4-23 to 4-26
- sources of EVs, 2-15 to 2-16, 4-1 to 4-2, 4-19. *See also* EV generators; generating EVs channels, 8-25
- electrodeless source, 8-11
 - illustration, 8-10
- electrons necessary for emitting, 6-8 to 6-9
- field emission diodes, 8-15 to 8-16
- film field sources, 8-19
 - illustrations, 8-20 to 8-21
- gaseous streamer sources, 6-9
 - illustration, 8-4
- inorganic gases, 8-9
- long sources, 8-22
- metal vapor sources, 8-5
- multielectrode sources, 8-22
- non-metallic cathode sources, 6-8
- nozzle structures for emitting, 2-16
- optical beam source, 9-6
- organic gases, 8-11
- "short" and "long" sources, 8-1
- surface source, 8-7
 - illustration, 8-6
- synchronous firing of, 2-11 to 2-12
 - triggers, 8-27
- space charge law, 1-7
- spherical monopole oscillator, 9-1 to 9-2
- Spindt, C.A., 5-17
- splash marks, 2-4
- splitters for EVs, 2-14, 8-39
 - illustrations, 8-38
- staff, project, 1-9
- streamers
 - charge granularity of, 6-7
 - display of, in Science Museum, San Diego, 6-1
 - effects seen, list of, 6-5 to 6-6
 - literature on, 6-2
 - pulsed RF power supply for, 6-2
 - streamer formation chamber, 6-4
 - illustration, 6-3
 - theories on, 3-12
 - witness plates of, 6-7
- strikes. *See* targets
- substrates, for guiding EVs, 2-12 to 2-15
- surface charging. *See* charging surfaces
- surface coating, effect on EVs, 3-9, 3-11
- surface field measurement, 9-4
- synchronizer for EVs, 8-32

T

- targets
 - aluminum-oxide film, 5-18 to 5-23, 5-26
 - carbon/chromium film, 5-1 to 5-3
 - conductive backing added, 5-3 to 5-5
 - pictures, 5-2, 5-3, 5-4 to 5-5
 - carbon without chromium, 5-5 to 5-7
 - picture, 5-6
 - cathodes and anodes, in scanning tunneling microscopes, 5-14 to 5-15
 - dielectric materials, 5-17 to 5-26
 - field emission diodes, 5-17
 - pictures, 5-16
 - gas and vacuum strikes, 5-13

targets (Continued)

- low-pressure xenon, 5-9 to 5-12
 - pictures, 5-10 to 5-12
- Tesla coil in air, 5-7 to 5-9
 - pictures, 5-7, 5-8
- Tesla coil in air, as target, 5-7 to 5-9
 - pictures, 5-7, 5-8
- thermionic pulse emissions, 4-39 to 4-40
- thick-film processing, 3-27
- Thomson, Joseph John, 3-13
- time jitter, 2-11, 2-12
- traveling waves
 - conclusion of efforts toward, 7-6
 - delay line for, 7-2
 - device description, 8-47
 - downsizing the tube, 7-5
 - EV coupling to traveling wave circuits
 - illustrations, 8-46
 - length limitations, 7-2
 - multiple EV generation, 7-4
 - results of test, 7-4 to 7-5
 - synchronized guidance for EVs, 7-1
 - tube design, 7-3
 - waveforms, 7-3 to 7-4
- triggers, for EV generation, 8-27
- tubing, fused-quartz, 4-55 to 4-58
- turning behavior of EVs, 4-14, 4-16
 - pictures, 4-15, 4-16
- twin EVs, 4-51
 - picture, 4-50

V

- vacuum arcs, 2-1
 - pictures of, 3-10
 - surface coating and, 3-9
- vacuum breakdown, on dielectric surface, 1-11 to 1-12
- vector potentials, 9-7 to 9-8
- velocity of EVs, 4-21, 9-7

- vortex filaments, 1-6 to 1-7, 1-10, 1-12
 - electromagnetic guidance for, 1-10
 - size experiments, 2-11 to 2-12, 2-21 to 2-23
 - pictures of, 2-22
 - theory of, overturned, 2-23

W

- water glass substrate, 2-14
- waveforms, 4-2 to 4-3
 - aperiodic waveforms, 8-35
 - measurement device, 4-20
- witness marks and plates, 2-1, 2-7, 2-9
 - pictures of, 2-2 to 2-4, 2-8
 - ring-shaped, 2-19 to 2-21
 - SEM pictures of, 2-10
 - streamer tests, 6-7
- work methods, 1-7 to 1-8
- working space, importance of, 1-1

X

X-rays

- emission spectrum, 4-12
- emitted by EVs, 2-17 to 2-18, 4-33, 4-35, 4-53
 - pictures, 4-34
- point x-ray source, 8-49
 - illustration, 8-48

xenon gas

- low-pressure, as target, 5-9 to 5-12
 - pictures, 5-10 to 5-12
- for producing streamers, 6-3

Z

- zero point fluctuation drive, 9-2